



ColorCube

User manual

Product Overview

Describes features for the product.

Setup

Describes setup and installation of the product and peripherals.

Handling

Describes how to handle the product.

Application Development Information

Describes how to control the printer and necessary information when you develop applications.

Maintenance

Describes the efficient management method of multiple printers and client computers, targeted at the administrators.

Appendix

Describes general specifications for the product.

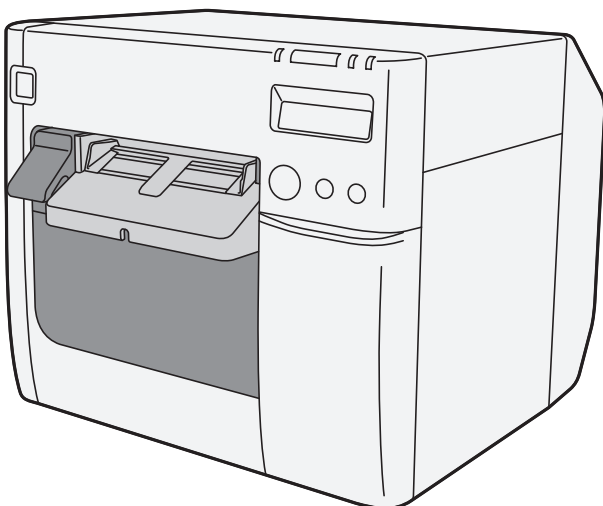





For Safety

Key to Symbols

The symbols in this manual are identified by their level of importance, as defined below. Read the following carefully before handling the product.

| | |
|---|--|
|  WARNING | You must follow warnings carefully to avoid serious bodily injury. |
|  CAUTION | Provides information that must be observed to prevent damage to the equipment or loss of data. <ul style="list-style-type: none">• Possibility of sustaining physical injuries.• Possibility of causing physical damage.• Possibility of causing information loss. |
| CAUTION | Provides information that must be observed to avoid damage to your equipment or a malfunction. |
| NOTE | Provides important information and useful tips. |

Warnings

| | |
|---|---|
|  WARNING | <ul style="list-style-type: none">• Shut down your equipment immediately if it produces smoke, a strange odor, or unusual noise. Continued use may lead to fire. Immediately unplug the equipment and contact your dealer or a Seiko Epson service center for advice.• Never attempt to repair this product yourself. Improper repair work can be dangerous.• Never disassemble or modify this product. Tampering with this product may result in injury or fire.• Use the specified AC Adapter, K (Model: M248A) only. Connection to an improper power source may cause fire.• Be sure your power code meets the relevant safety standards and includes a power-system ground terminal (PE terminal). Otherwise electric shock may result. If you acquire a system with different safety standards, use an AC cable that meets the acquired safety standards.• Do not allow foreign matter to fall into the equipment. Penetration by foreign objects may lead to fire.• If water or other liquid spills into this equipment, unplug the power cord immediately, and then contact your dealer or a Seiko Epson service center for advice. Continued usage may lead to fire.• Do not use aerosol sprayers containing flammable gas inside or around this product. Doing so may cause fire. |
|---|---|

Cautions



- Do not connect cables in ways other than those mentioned in this manual. Different connections may cause equipment damage and burning.
- Be sure to set this equipment on a firm, stable, horizontal surface. The product may break or cause injury if it falls.
- Do not use in locations subject to high humidity or dust levels. Excessive humidity and dust may cause equipment damage or fire.
- Do not place heavy objects on top of this product. Never stand or lean on this product. Equipment may fall or collapse, causing breakage and possible injury.
- Protect the printer from heavy impacts. They may cause defective print.
- To ensure safety, unplug this product before leaving it unused for an extended period.
- Do not remove the ink cartridge from the product when you ship it.
- Be sure to note the following when using the ink cartridge:
 - * Do not turn off the product or open the ink cartridge cover while charging ink (Power light is flashing). Opening the cover may cause the ink to be recharged, resulting in more ink being consumed. Also, it may cause printing malfunction.
 - * Do not disassemble the ink cartridge. Doing so may cause ink to adhere eyes and skin.
 - * Do not disassemble and remodel the ink cartridge. Doing so may cause printing malfunction.
 - * Keep ink cartridges out of the reach of children.
- If ink contacts your skin, eyes, or mouth, take the following actions.
 - * When ink gets onto your skin, immediately wash the area with soap and water.
 - * When ink gets into your eyes, immediately flush them with water.
 - * Leaving the ink as is may result in bloodshot eyes or mild inflammation. If something is wrong, immediately consult with a doctor.
 - * When ink gets into your mouth, immediately spit it and consult with a doctor.
- Be sure to note the following when using the maintenance box:
 - * Do not dismantle the Maintenance box.
 - * Do not touch the IC chip on the cartridge.
 - * Keep out of reach of children, and do not drink.
 - * Do not reuse a maintenance box which was removed and detached for a long period.

Restriction of Use

When this product is used for applications requiring high reliability/safety such as transportation devices related to aviation, rail, marine, automotive etc.; disaster prevention devices; various safety devices etc.; or functional/precision devices etc., you should use this product only after giving consideration to including fail-safes and redundancies into your design to maintain safety and total system reliability.

About this Manual

Aim of the Manual

This manual was created to provide information on development, design, and installation of systems and development and design of printer applications for developers.

The specifications of the supported paper sizes are different for the firmware covered in this manual and the firmware that has been upgraded.

Manual Content

The manual is made up of the following sections:

| | |
|-----------|---|
| Chapter 1 | Product Overview |
| Chapter 2 | Setup |
| Chapter 3 | Handling |
| Chapter 4 | Application Development Information |
| Chapter 5 | Maintenance |
| Chapter 6 | Appendix |

Contents

| | |
|-----------------------------------|----------|
| ■ For Safety | 3 |
| Key to Symbols | 3 |
| Warnings | 3 |
| Cautions | 4 |
| ■ Restriction of Use | 5 |
| ■ About this Manual | 6 |
| Aim of the Manual | 6 |
| Manual Content | 6 |
| ■ Contents | 7 |

Product Overview

| | |
|--|-----------|
| ■ Features | 11 |
| Easy Setup | 13 |
| How to Print | 13 |
| Other Features | 13 |
| ■ Parts Name and Function | 14 |
| Power Switch | 16 |
| Paper FEED button | 16 |
| CUT button | 17 |
| Cleaning button | 17 |
| STATUS SHEET button | 18 |
| LCD contrast adjustment button | 18 |
| Connectors | 19 |
| ■ Status/Error Indications | 20 |
| Ink Cartridge and Maintenance Box Status | 22 |
| Beeper | 23 |
| ■ Auto nozzle check system | 24 |
| ■ Drivers, Utilities | 27 |
| Drivers | 27 |
| Utilities | 28 |

Setup

| | |
|---|-----------|
| ■ Work Flow | 29 |
| ■ Checking the Items Included in the Package | 30 |
| ■ Installing the Printer | 31 |
| Important Notes on Installation | 31 |
| ■ Attaching the Power Switch Cover | 32 |
| ■ Setting Up the Printer | 34 |
| Media Layout Creation | 36 |
| Shutter Adjustment | 40 |
| ■ Ejection Angle of Printed Paper | 42 |

| | |
|---|----|
| ■ How to Display the Printer Driver..... | 43 |
| ■ Registering the Media Layout | 45 |
| ■ Attaching the Paper Ejection Tray | 46 |
| ■ Setting the DIP Switches..... | 48 |
| Setting Procedure..... | 48 |
| Function of the DIP Switches | 49 |
| ■ Setting the Printer Driver | 50 |
| Banding Reduction | 50 |
| TM-C3500 PrinterSetting | 52 |
| Setting EPSON Status Monitor 3..... | 54 |

Handling 61

| | |
|--|-----|
| ■ Replacing the Ink Cartridge | 61 |
| ■ Replacing Maintenance Box | 64 |
| ■ Replacing Roll Paper with Fanfold Paper..... | 66 |
| ■ Replacing Fanfold Paper with Roll Paper..... | 75 |
| ■ Setting the Printer Driver | 83 |
| Favorite Setting | 83 |
| Information for User Definition | 86 |
| Exporting/Importing Printer Driver Settings | 87 |
| Barcode Printing | 89 |
| 2D Symbol Font Settings..... | 101 |
| Barcode and 2D Symbol Font Printing on .NET Environment..... | 108 |
| Print Preview | 110 |
| Settings For Paper Handling After Print | 111 |
| Beeper | 113 |
| ■ Setting the Printer | 114 |
| Media detection settings | 114 |
| Nozzle Check Mode Settings | 117 |
| Paper Loading Settings..... | 119 |
| Notification Settings..... | 122 |
| Panel Button Settings | 124 |
| Operating Time Settings..... | 126 |
| Paper Feed Adjustment..... | 128 |
| Sensor Adjustment | 135 |
| Print Head Alignment..... | 136 |
| ■ Network Interface | 137 |
| Factory settings..... | 137 |
| How to initialize the settings to the factory settings..... | 137 |
| ■ Troubleshooting | 138 |
| Trouble Recovery Method | 138 |
| Error Recovery Method | 151 |
| When the print result is faint or white lines or black lines are printed | 154 |
| When the printer is not found even if EpsonNet Config is started | 156 |
| HELP for EPSON Printers | 157 |
| ■ Setting Check Modes | 159 |
| Self-test Mode | 159 |

| | |
|--|------------|
| Status Sheet Printing (LAN interface model only) | 161 |
| ■ Reset | 162 |
| ■ Cleaning the Printer | 162 |
| Cleaning the platen | 162 |
| Cleaning the Autocutter | 164 |
| ■ Media arrangement | 165 |
| Media arrangement when feeding media for printing from the first sheet | 165 |
| Media arrangement for printing on the last sheet | 167 |
| ■ Setting the label size and paper layout for borderless printing | 170 |
| Requirement | 170 |
| Setting example | 170 |
| ■ How to Make Media Settings | 172 |

Application Development Information..... 173

| | |
|---|------------|
| ■ Printer Control Method | 173 |
| ■ Printer Driver | 173 |
| ■ Using Epson Inkjet Label Printer SDK | 174 |
| Operating environment | 174 |
| Where to download | 174 |
| ■ Utilities and Manuals | 175 |
| Download | 178 |

Maintenance..... 179

| | |
|--|------------|
| ■ Necessary Information for an Administrator of the Printer | 181 |
| Utility | 181 |
| Setting the Printer | 182 |
| Setting the Printer Driver | 183 |
| ■ System Configuration | 185 |
| Installing the Printer | 185 |
| Distributing the Printer Driver | 186 |
| ■ Maintenance | 187 |
| Changing the Printer Settings | 187 |
| Changing the Printer Driver Settings | 192 |
| Monitoring the Network Printer | 193 |
| Replacing the Printer | 194 |
| ■ For Inquiries | 196 |

Appendix..... 197

| | |
|---------------------------------------|------------|
| ■ Product Specifications | 197 |
| Hardware Requirements | 198 |
| Printing Specifications | 199 |
| Paper Specifications | 199 |

| | |
|---------------------------------------|------------|
| Print Area and Cutting Position | 210 |
| Paper Ejection Tray | 230 |
| Ink Cartridge | 230 |
| Maintenance Box | 231 |
| Electrical Characteristics | 231 |
| Environmental Conditions | 232 |
| External Dimensions | 233 |
| ■ Restrictions | 234 |

Product Overview

This chapter describes features and specifications of the product.

Features

The LASSIE2 Plus series are a 4-color ink jet printer that offers high speed easy operability and high reliability required for on-demand label printing.

Printing

- High-speed printing
 - * 103 mm/s (printing width 56 mm, 360 dpi × 360 dpi, bidirectional printing)
 - * 52 mm/s (printing width 56 mm, 720 dpi × 360 dpi, bidirectional printing)

NOTE

The print speed is different depending on the resolution and the printing width.

- Color printing
 - * KCMY 4-color printing
 - * Print resolution: Plain, Plain label 360 dpi × 360 dpi
: Others 360 dpi × 360 dpi, 720 dpi × 360 dpi
dpi: dots per 25.4 mm (dots per inch)
- Supports printing on various types of paper
 - * Roll paper, Fanfold paper
 - * Continuous paper, Continuous paper (Blackmark), Full-page label, Transparent full-page label, Die-cut label, Transparent die-cut label
(Detects positions of black marks and gaps between labels)
 - * Plain, Matte, Plain label, Matte label, Synthetic label, Glossy label
 - * Wristband
- System to prevent ink from smearing out of the printable area such as on the backing paper of Die-cut Label.
- System to prevent missing read or missing color caused by missing dots.

Handling

- Replacing the roll paper and the ink cartridge can be done only by operation in the front.
- Multiple printed sheets can be stored in the paper ejection tray. The paper ejection tray cannot store multiple sheets of roll paper.

Reliability

| | | |
|------|----------------------|--|
| Life | Print head | 6 billion shots/nozzle |
| | Paper feed mechanism | <p>1,500,000 pages or the number of pages that reaches the following paper length fed.</p> <ul style="list-style-type: none"> • Plain Media: 150 km • Matte Media: 75 km • Wrist band (WB-S/M/L series): 30 km • Die-cut label (Plain Media): 150 km • Die-cut label (Matte Media): 150 km • Die-cut label (Synthetic Media): 100 km • Die-cut label (Glossy Media): 100 km • Continuous label paper (Plain Media): 100 km • Continuous label paper (Matte Media): 50 km • Continuous label paper (Synthetic Media): 10 km • Continuous label paper (Glossy Media): 30 km |
| | Autocutter mechanism | <ul style="list-style-type: none"> • Plain Media: 1,500,000 cuts • Matte Media: 750,000 cuts • Wrist band (WB-S/M/L series): 200,000 cuts • Die-cut label backing paper (Plain Media): 1,500,000 cuts • Die-cut label backing paper (Matte Media): 1,500,000 cuts • Die-cut label backing paper (Synthetic Media): 500,000 cuts • Die-cut label backing paper (Glossy Media): 1,500,000 cuts • Continuous label paper (Plain Media): 750,000 cuts (Add extra 250,000 cuts with cleaning the cutter blade) • Continuous label paper (Matte Media): 500,000 cuts • Continuous label paper (Synthetic Media): 100,000 cuts • Continuous label paper (Glossy Media): 300,000 cuts |
| | Carriage mechanism | 6 million passes (3 million carriage returns) |
| MTBF | | 88,000 hours |
| MCBF | | 9,800,000 passes |

Easy Setup

Using the CD-ROM that came with the product, you can follow the dialogic instructions on the screen and easily setup a printer driver, install software, or perform media settings and settings of this product.

How to Print

- Windows printer drivers that can be used from Windows applications (except for the above label printing applications) are available.
- The printer driver has a built-in barcode font and can print high quality barcodes with superior readability. It can also be used from a .NET environment application.
- EPSON Inkjet Label Printer SDK (using a Windows printer driver) that supports the customer's printing application development is available.

Other Features

- USB interface and Ethernet interface are equipped by default. This product can be used as a local printer of a computer or a network printer.
- The auto-cutter is equipped by default. Paper can be cut by a command from applications or panel switch operations.
- A beeper is equipped by default. Notifications are available for no media or low ink, error, end of printing, etc.
- When using a USB printer, because a new print queue is generated when the damaged printer is replaced with another printer, you need to set the application or driver again. However for this product, we provide the service (USB printer class device replacing service) to replace a printer without changing the settings of a computer or printer driver.

Parts Name and Function

Front

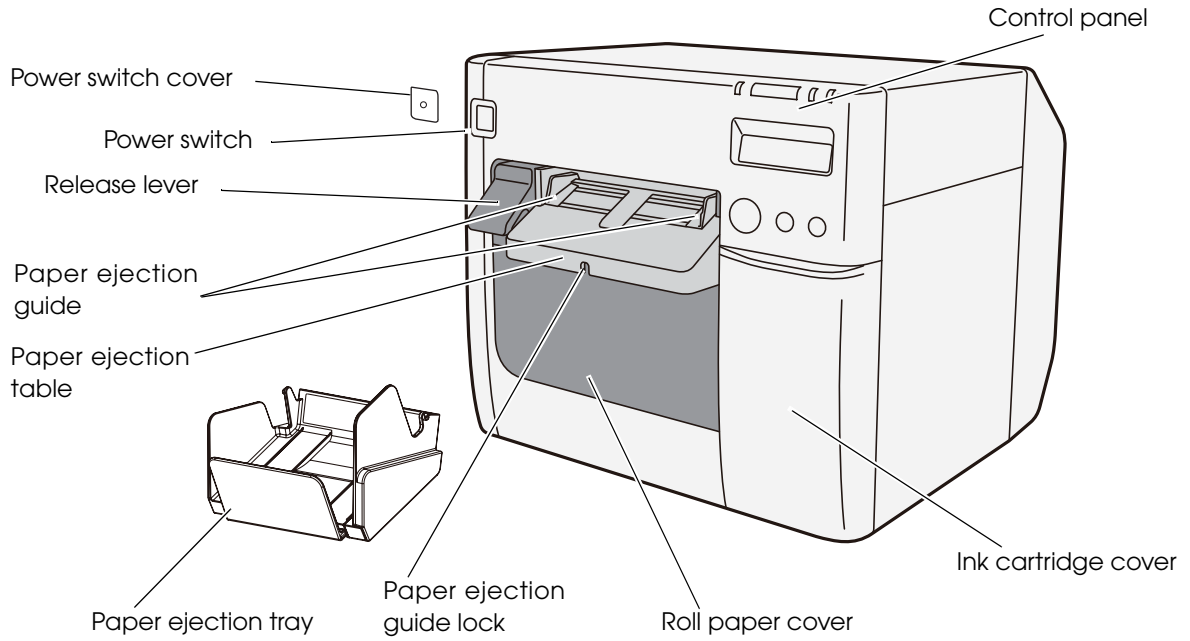

Control panel

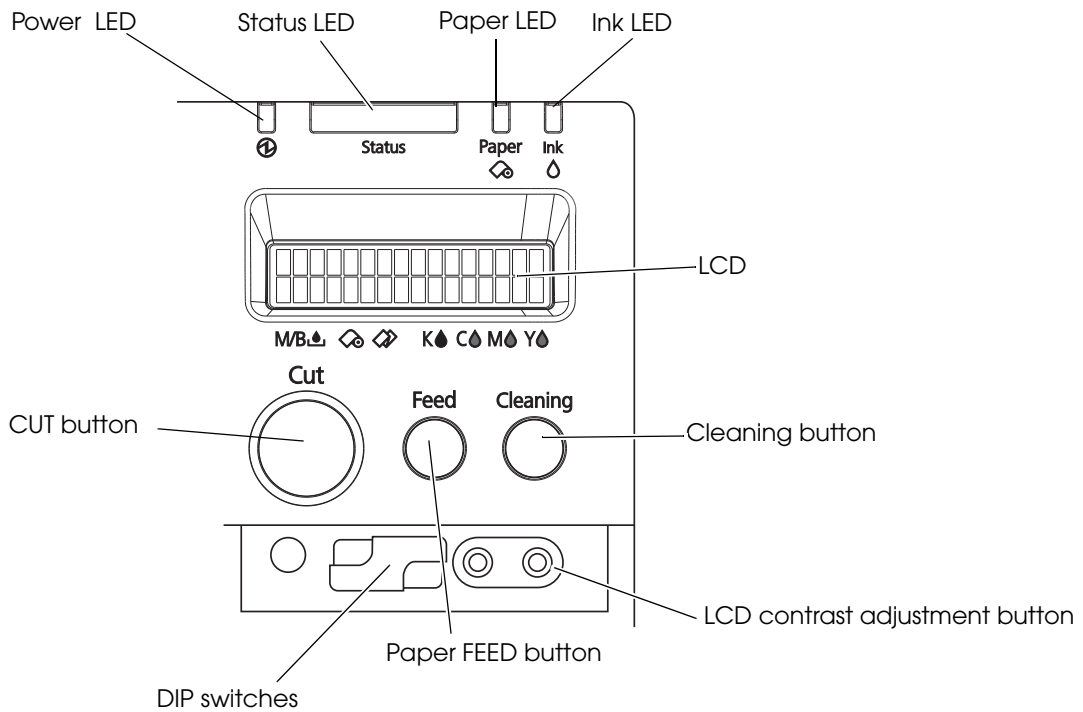

Back

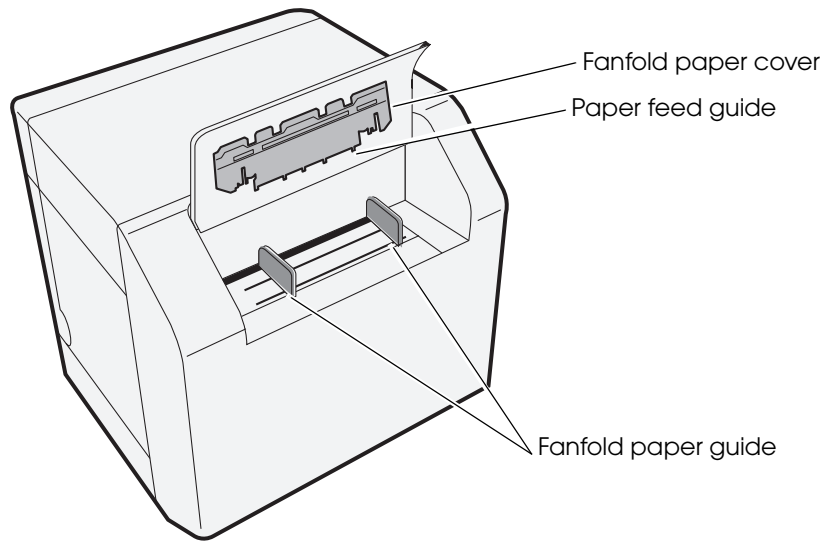

Connector (lower rear)

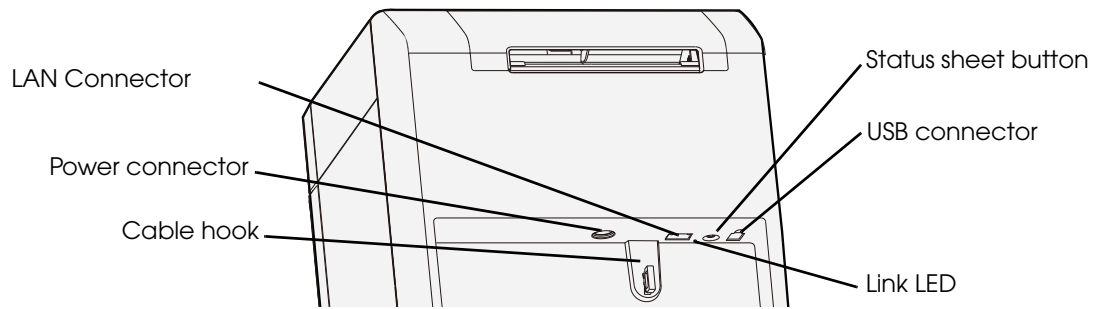

Power Switch



Before turning on the printer, be sure to check that the AC adapter is connected to the power supply.

- ❑ When DIP switch 1 is OFF:
 - Turns the power on after the POWER button has been pressed while the power is OFF.
 - Turns the power off after the POWER button has been pressed for approximately 0.5 seconds while the power is ON.
- ❑ When DIP switch 1 is ON:
 - Resets the printer after POWER button has been pressed for approximately 0.5 seconds.



See ["Setting the DIP Switches" on page 48](#) for DIP switch setting.

Paper FEED button

- ❑ If "Media detection settings" is set to "Full-page label/Continuous paper/Transparent full-page label", feeds the paper continuously.
 - The paper is fed by 15 mm if FEED button is pressed once.
 - If the FEED button is held down, the paper is continuously fed until the button is released. (6 seconds at a maximum)
- ❑ If "Media detection settings" is set to "Die-cut label (Blackmark)", "Continuous paper (Blackmark)", or "Die-cut label (Gap)/Transparent die-cut label", feeds the paper to the print starting position.



When the printer is in the power saving mode when its vacuum fan is stopped, starting up and stabilizing the rotation of the vacuum fan requires some time. Approximately 2 seconds is required from the point when the paper FEED button is pressed until the point when paper feed starts.

CUT button

- ❑ If "Media detection settings" is set to "Full-page label/Continuous paper/Transparent full-page label", feeds the paper to the autcutting position for the top of the next page, and performs autcutting.
- ❑ If "Media detection settings" is set to "Die-cut label (Blackmark)", "Continuous paper (Blackmark)", or "Die-cut label (Gap)/Transparent die-cut label", feeds the paper to the autcutting position according to the black mark or the gap between labels, and performs autcutting.

NOTE

- However, in order to prevent errors due to pieces of paper, even if you press the cut button again, cutting is not performed in a position where cutting was already performed.
- Approximately 2 seconds is required from the point when the CUT button is pressed until the point when paper cut starts.

Cleaning button

If the cleaning button is held down for approximately 3 seconds, head cleaning is performed.

The following settings are possible from the driver regarding cleaning operations when the cleaning button is held down.

| No. | During stand-by | During printing |
|-----|-------------------------|--|
| 1 | Disabled | Disabled |
| 2 | Head cleaning performed | Disabled |
| 3 | Head cleaning performed | Printing canceled -> head cleaning performed -> printing resumed |

STATUS SHEET button

Press the status sheet button to print the status sheet.

If you turn on the power while holding the status sheet button, and continue to hold it for 10 seconds or more, you can return the LAN interface settings to factory default settings.

LCD contrast adjustment button

Adjusts the LCD contrast.

NOTE

- The LCD contrast adjustment button is located under the ink cartridge cover.
- The adjusted value is saved in the non-volatile memory. Even after the power is turned on again, the adjusted value saved last time is applied.

Connectors

All cables are connected to the connector on the lower rear of the printer.

- Power supply connector: Connects cable of the AC adapter.
- USB/LAN Connector: Connects the printer with the host computer via interface.
- Link LED: Indicates the printer network status.

| Printer status | Link LED |
|------------------------------|----------|
| Power off | Off |
| Not connected to the network | Off |
| Network established | On |
| Receiving data | Blinking |

Status/Error Indications

The printer status is indicated by a combination of LED lighting/flashing and LCD indication.





When an error occurs, you can find out the cause and the remedy from the LED & LCD indication for the error.

































NOTE

- The LCD display language can be switched with the DIP switches. See "[Setting the DIP Switches](#)" on page 48.
- For error recovery methods, see "[Troubleshooting](#)" on page 138 or the help for the driver. (For details on how to display HELP for EPSON Printers, see the help for the driver on page 144.)

/ : Lit up / : Blinking : Off — : No change ## : Error code

| LED | | | | LCD | Printer Status |
|--------|--------|-------|-----|------------------|---------------------------------|
| Status | Power | Paper | Ink | | |
| | | — | — | READY | In ready |
| | | — | — | INITIALIZING | In initializing |
| | (Fast) | — | — | POWER OFF | In power off sequence |
| | | — | — | PRINTING | In printing |
| | | — | — | INK CHARGING | In ink charging |
| | | — | — | WORKING | In working |
| | | — | — | HEAD MAINTENANCE | In print head maintenance state |
| | — | | — | MEDIA FORM ERROR | Media form error (*) |
| | — | | — | MEDIA SIZE ERROR | Media size error (*) |
| | — | | — | PAPER JAM ERR ## | Paper jam error (*) |
| | — | | — | PAPER REMOVAL ER | Paper removal error (*) |
| — | — | | — | PAPER OUT | Paper out (*) |
| | — | | — | PAPER OUT ERROR | Paper out error (*) |
| | — | | — | ROLL COVER OPEN | Roll paper cover open (*) |
| | — | — | | INK COVER OPEN | Ink cartridge cover open (*) |
| | — | — | | NO INK CARTRIDGE | No ink cartridge (*) |
| | — | — | | INK READ ERROR | Ink cartridge read error (*) |
| | — | — | | M/B COVER OPEN | Maintenance box cover open (*) |
| | — | — | | NO MAINT BOX | No maintenance box (*) |

 /  : Lit up
  /  : Blinking
  : Off
 — : No change
 ## : Error code

| LED | | | | LCD | Printer Status |
|---|---|---|---|------------------|------------------------------------|
| Status | Power | Paper | Ink | | |
|  | — | — |  | M/B READ ERROR | Maintenance box read error (*) |
| — | — | — |  | INK LOW | Ink cartridge low |
|  | — | — |  | REPLACE INK | Replace ink cartridge (*) |
| — | — | — |  | M/B NEAR FULL | Maintenance box near full |
|  | — | — |  | REPLACE MAINT B | Replace maintenance box (*) |
| — | — | — | — | NOZZLE CLOGGED | Print head nozzle clogged (*) |
| — | — | — | — | CUT UNAVAILABLE | In cutter unavailable state (*) |
| — | — | — | — | SERVICE SOON ## | In service mode (*) |
|  |  |  |  | PRINTER ERROR ## | Printer error (*) |
|  |  |  |  | SERVICE REQD. ## | Service required (*) |
|  /  |  |  /  |  /  | UPDATING | In firmware updating (*) |
|  /  |  |  |  | UPDATING | Complete the firmware updating (*) |
|  /  |  |  |  | UPDATING | Failure in firmware updating (*) |

* Recovery method: See "[Troubleshooting](#)" on page 138.

Ink Cartridge and Maintenance Box Status

You can check the status of the printer, the ink cartridges of each color, and the maintenance box from the LCD.

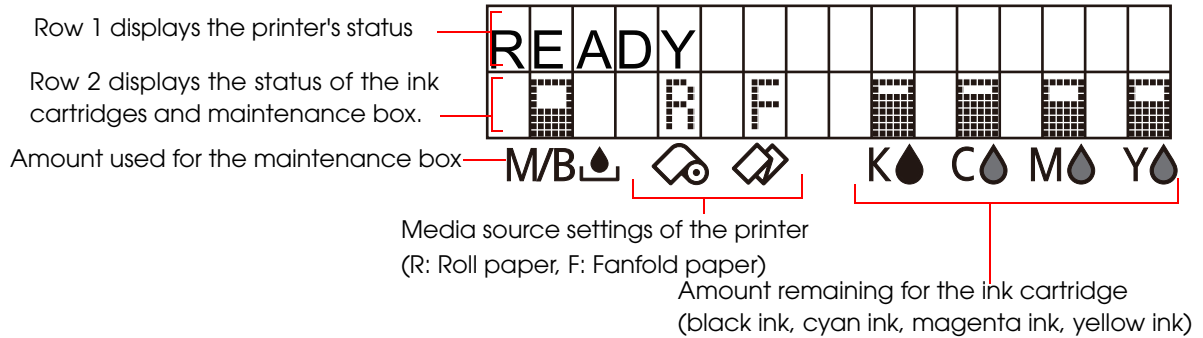

Display of the ink cartridge, maintenance box status

Displays the status of ink cartridges and maintenance box with icons.

| Icon | Status |
|------|--|
| | <ul style="list-style-type: none"> • Display of amount remaining for the ink cartridge • Display of amount used for the maintenance box |
| | <ul style="list-style-type: none"> • Display for "Ink cartridge low" • Display for "Maintenance box near full" |
| | <ul style="list-style-type: none"> • Display for "Replace ink cartridge" • Display for "Replace maintenance box" |
| | <ul style="list-style-type: none"> • Display for "No ink cartridge" • Display for "Ink cartridge read error" • Display for "No maintenance box" • Display for "Maintenance box read error" |

Beeper

When an error occurs while “Beep Notification Setting at an Error” is enabled, the beeper performs “Sound the beeper on an error” shown in the below table. The beeper continues to beep until all the causes of error are removed.

When “Settings For Paper Handling After Print” - “Notification” is enabled, the printer performs “Beeper sound when the printer is not in an error state” shown in the below table.

- Frequency: Fixed to approximately 2.5 kHz
- Volume control: 2 levels on the hardware

| Sounding period | Silent period | Number of the pattern repeated | Overall time | Number of times repeated | Printer event |
|-----------------|---------------|--------------------------------|--------------|------------------------------------|--|
| 500ms | 300ms | 3 | 5 seconds | Until the error factor is removed. | Sound the beeper on an error <ul style="list-style-type: none"> • Service required • Printer error • Roll paper cover open • Ink cartridge cover open • Replace ink cartridge • No ink cartridge • Ink cartridge read error • Maintenance box cover open • Replace maintenance box • No maintenance box • Maintenance box read error • Media form error • Media size error • Paper jam error • Paper removal error • Paper out error |
| 300ms | - | None | - | 1 | Beeper sound when the printer is not in an error state <ul style="list-style-type: none"> • Every page • The final page only |

NOTE

- The volume can be set using the DIP switch. See ["Setting the DIP Switches" on page 48](#).
- When the paper is in “Paper out” status, which is without printing data, the beeper does not sound.

Auto nozzle check system

This product has an “Auto nozzle check system” that detects missing dots. You can select the “Nozzle check mode” depending on level of requirement for missing dots.

The following table shows the timing for auto nozzle check for each nozzle check mode (printing operation mode).

| Timing for auto nozzle check | Anti-missing Dot Mode | Anti-missing Read Mode (default) | Anti-missing Color Mode | No Missing Dot Detection Mode |
|--|------------------------------|---|--------------------------------|--------------------------------------|
| At printer power-on | Performed | Performed | Performed | Not Performed |
| During a pause | Performed | Performed | Performed | Not Performed |
| After printing page | Not Performed | Not Performed | Not Performed | Not Performed |
| Regular check during continuous printing | Performed | Performed | Performed | Not Performed |
| After cleaning the print head | Performed | Performed | Performed | Not Performed |
| After closing the roll paper cover | Performed | Performed | Performed | Not Performed |
| After closing the ink cartridge cover | Performed | Performed | Performed | Not Performed |
| After closing the maintenance box cover | Performed | Performed | Performed | Not Performed |
| After detecting a shock | Performed | Performed | Performed | Not Performed |

The following table shows the conditions for permitted missing dots and auto cleaning for each nozzle check mode.

| Condition | Anti-missing Dot Mode | Anti-missing Read Mode (Default) | Anti-missing Color Mode | No Missing Dot Detection Mode |
|--------------------------|-----------------------|----------------------------------|--|-------------------------------|
| Permitted missing dots | None | 1 missing dot or less | No 2 consecutive missing dots and less than 9 missing dots | - |
| Auto cleaning conditions | 1 missing dot or more | 2 missing dots or more | 3 or more consecutive dots or 10 or more missing dots | - |

- **Anti-missing Dot Mode**

The auto nozzle check is performed at each timing, and by performing the auto head cleaning when necessary, missing dots are prevented.

NOTE

- Because the nozzle check is performed periodically during continuous printing, printing may be interrupted for approximately 8 seconds.
- If more than 1 missing dot is detected, the auto head cleaning is performed to resolve the missing dot.

- **Anti-missing Read Mode**

The auto nozzle check is performed at each timing, and by performing the auto head cleaning when necessary, missing reads due to missing dots are prevented.

NOTE

- Because the nozzle check is performed periodically during continuous printing, printing may be interrupted for approximately 8 seconds.
- If more than 2 missing dot is detected, the auto head cleaning is performed to resolve the missing dot.

- **Anti-missing Color Mode**

The auto nozzle check is performed at each timing, and by performing the auto head cleaning when necessary, missing colors due to missing dots are prevented.

NOTE

- Because the nozzle check is performed periodically during continuous printing, printing may be interrupted for approximately 8 seconds.
- If 3 or more consecutive missing dots or 10 missing dots or more are detected, the auto head cleaning is performed to resolve the missing dots.

- No Missing Dot Detection Mode

The auto nozzle check and the auto head cleaning are not performed.

CAUTION

- This "Auto nozzle check" system cannot detect 100% of dot missing cases.
- In cases extremely high reliability and safety is required, Epson recommends the use of font constructed of 3 vertical dots or more in "Anti-missing Dot Mode" or "Anti-missing Read Mode" to prevent misreadings due to missing dots or ink drop distortions.
- If an unfixable clogged nozzle occurs during auto cleaning after missing dot detection, the following operations will be performed.
 - * If missing dots are not less than the auto cleaning conditions even after auto cleaning is repeated, "Print head nozzle clogged" warning occurs.
 - * Auto cleaning conditions during the "Print head nozzle clogged" warning status are available only when a new missing dot error occurs.
- Printer behavior during "Print head nozzle clogged" warning status
 - * When the number of missing dots is within the permitted amount, printing can be continued. The LCD displays [NOZZLE CLOGGED].
 - * When the number of missing dots exceeds the permitted amount, a printer error occurs and printing is disabled.

NOTE

- A very small amount of ink is used in the missing dot detection.
- After detecting a missing dot, cleaning is performed automatically and ink is also used in the cleaning.
- In [Anti-missing Dot Mode], [Anti-missing Read Mode], and [Anti-missing Color Mode] the auto nozzle check is performed at certain intervals, so the auto nozzle check may occur even during printing.

Drivers, Utilities

Various utilities are provided to system administrators and application developers.

For details on how to get the software, see "[Download](#)" on page 178.

Drivers

| Category | Name | Description |
|----------|--------------------------------|--|
| Windows | TM-C35xx Printer Driver | <p>Driver for printing from the application using Windows spooler service.</p> <p>The following functions are available besides the print function:</p> <ul style="list-style-type: none"> • Checking the printer status (EPSON Status Monitor) • Changing the printer settings (TM-C3500 PrinterSetting) <p>This driver is included in the supplied CD-ROM.</p> |
| | Epson Inkjet Label Printer SDK | <p>Information and software (SDK) necessary for developing applications that use this product.</p> <p>The following information and functions are available:</p> <ul style="list-style-type: none"> • Changing the printer driver's print settings (Epson Printer Driver Interface/EPDI) • Checking the printer status (EpsonNet SDK) • Sample program for printing by this printer (Epson Inkjet Label Printer Sample Program) |

Utilities

| Category | Name | Description |
|-------------|--|---|
| Deployment | Install Navi | Utility that carries out setting up this printer on one host PC. Performs the initial settings of the host PC and this product in a wizard format. This utility is included in the supplied CD-ROM. |
| Deployment | EPSON Deployment Tool | Utility for installing multiple printers efficiently. The following functions are available: <ul style="list-style-type: none"> • Batch initial setting of multiple printers (EPSON Printer Deployment) • Batch initial setting of multiple host PCs (EPSON Driver Deployment) |
| | EpsonNet SetupManager | Utility for creating a driver installation package that can be distributed to multiple host PCs. Start this from the EPSON Deployment Tool. |
| Management | EpsonNet Config | Utility for changing the printer's network settings. This utility is included in the supplied CD-ROM. |
| | EPSON Monitoring Tool | Utility for managing multiple printers that are installed. The following functions are available: <ul style="list-style-type: none"> • Monitoring the printer • Changing the printer settings • Supporting when the printer malfunctions |
| Maintenance | USB Printer Class Device Replacement Service | Utility that supports replacement work when the printer malfunctions. The host PC settings can be passes on to the newly connected product. This utility is included in the supplied CD-ROM. |

Setup

This chapter describes setup and installation of the product and peripherals.

Work Flow

This chapter consists of the following sections along with the setup flow of the product and peripherals.

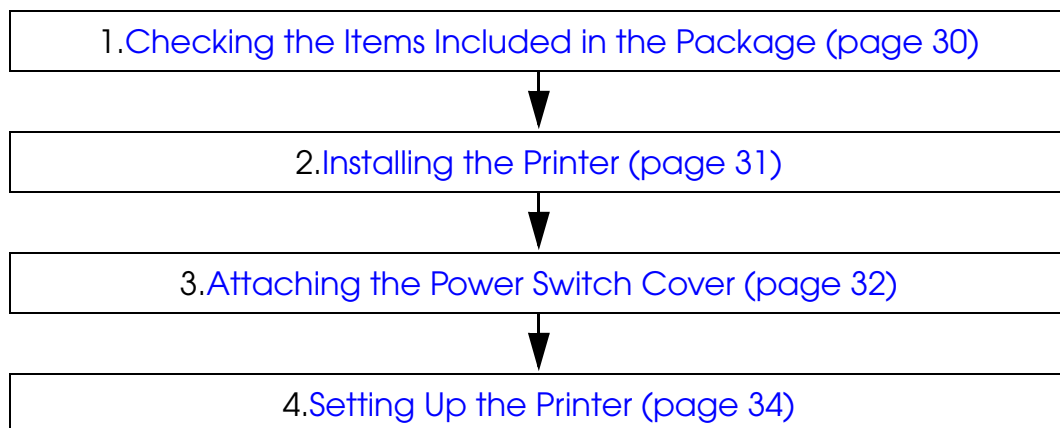

Checking the Items Included in the Package

When using the printer for the first time, check the items included in the package.

The items included in the package are as follows:

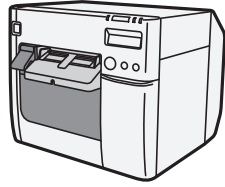

A

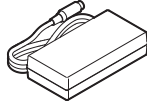

B



C

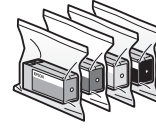

D

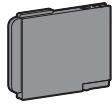

E



F

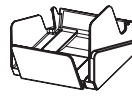

G

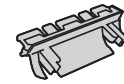

H



I

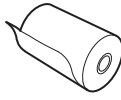

J

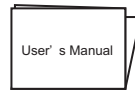

K



L

| | | | | | |
|---|---------------------|---|----------------------|---|--------------------|
| A | TM-C3500 Series | B | Dedicated AC adapter | C | AC cable *1 |
| D | Ink cartridge | E | Maintenance box | F | USB cable |
| G | Paper ejection tray | H | Paper feed guide *2 | I | Power switch cover |
| J | Label roll paper | K | User's Manual | L | CD-ROM |

*1 The AC cable may not be included with the product.

*2 Attached on the rear of the fanfold paper cover.

Installing the Printer

Install the printer in an appropriate location with sufficient space around it.

Important Notes on Installation

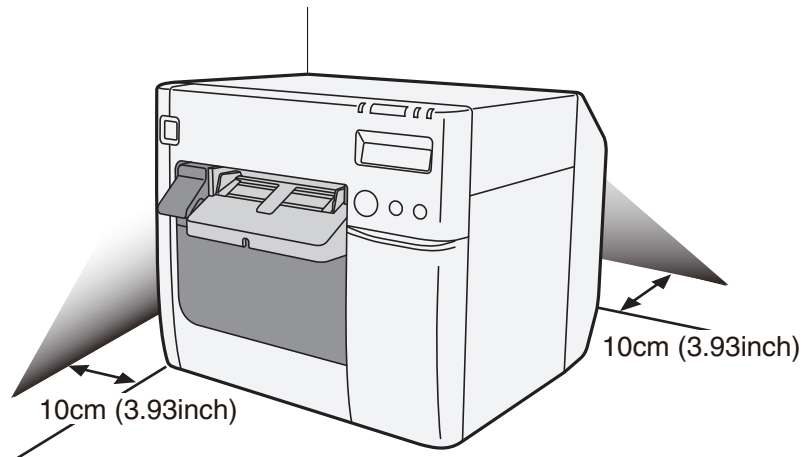

- The printer must be installed horizontally.
- Leave enough space in front of the printer for the ink cartridge cover and the roll paper cover to be fully opened.
- Do not place the printer in a dusty location.
- Do not allow cables to get caught or foreign matter to accumulate under the printer.
- Make sure that there is at least 100 mm of space behind the printer back when installing.
- Do not put a heavy object (of 10 kg or more) or an object that vibrates on the printer.

Attaching the Power Switch Cover

Attaching the power switch cover prevents accidental pressing of the power switch.

CAUTION

Before attaching the power switch cover, set DIP switch 1 to ON. (For details, see “Setting the DIP switches” [Setting the DIP Switches on page 48.](#)) The printer power can then be switched by turning the AC supply on and off, and you can also control the printer power with a device such as a distribution board. In this case, the power switch is used to reset the printer.

To prevent the power switch from being pressed

Attach the power switch cover as it is (without punching a hole in it).

- 1 Set DIP switch 1 to ON.
- 2 Push the power switch cover onto the power switch of the printer.

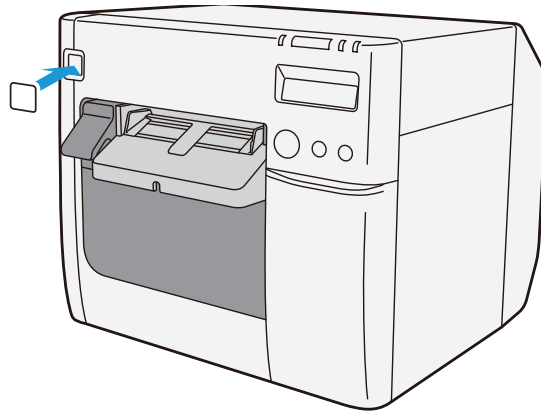

To operate the power switch by inserting a long, thin object into a hole
Attach the power switch cover after punching the hole in it.

CAUTION

The hole cannot be punched in the power switch cover after it is attached to the printer.

- 1** Punch a hole in the power switch cover by pushing the middle of it with a hard, fine-tipped object.
- 2** Push the power switch cover onto the power switch of the printer.

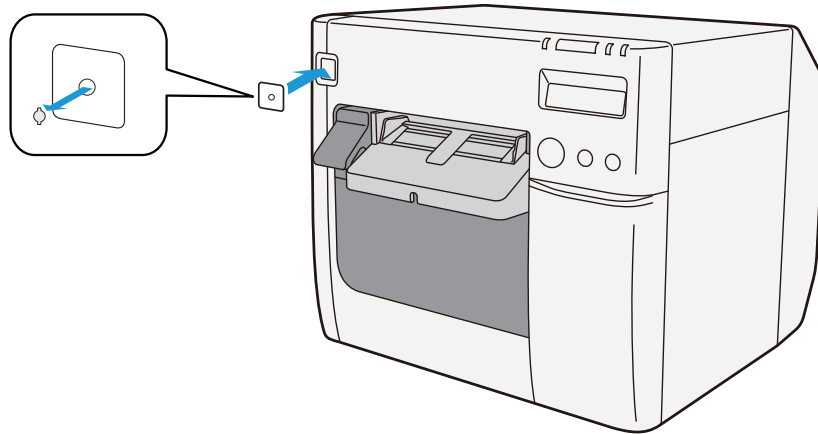

Setting Up the Printer

Set up the printer using Install Navi. Install Navi is included in the supplied CD-ROM.

- 1 Turn on the computer to be connected to the printer.
- 2 Make sure that the printer is turned off.

CAUTION

Be sure to turn the printer off.

- 3 Set the CD-ROM in the computer, and Launcher automatically starts up. Click (Setup) to start InstallNavi.exe.
- 4 When Install Navi is executed, the following window appears. Agree to the license agreement and click (Next), and the software installation starts. Set up the printer according to the displayed instruction.

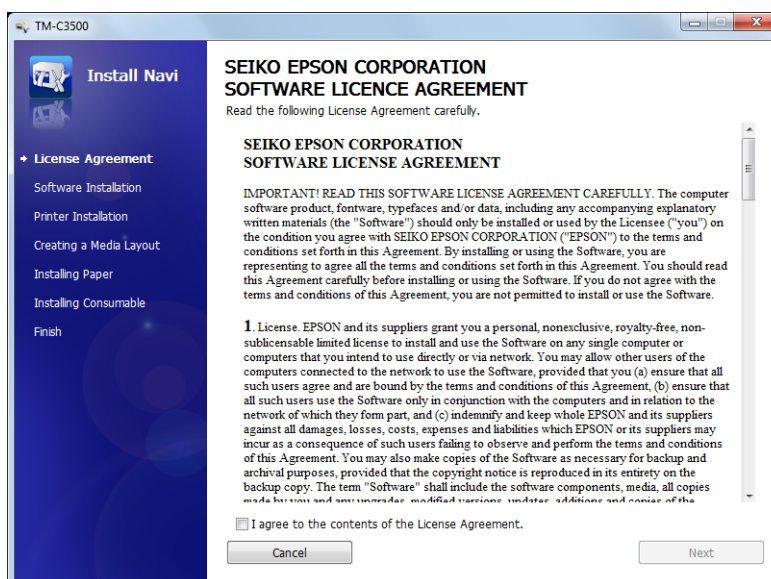

- 5** Later in the setup procedure, "Media Layout Creation" window appears. When "Media Layout Creation" window appears, if you do not use the roll paper included in the package, you have to create a new media layout. For the procedure to create a new media layout, see [Media Layout Creation on page 36](#).
To use the supplied roll paper, select (No).

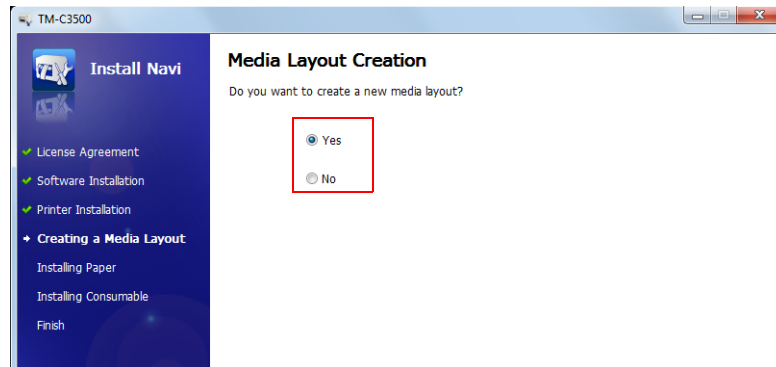

- 6** Set up the printer according to the steps. If test printing finishes successfully, the procedure is finished.

Media Layout Creation

- 1 On "Media Layout Creation" window, select (Yes) and Click (Next).

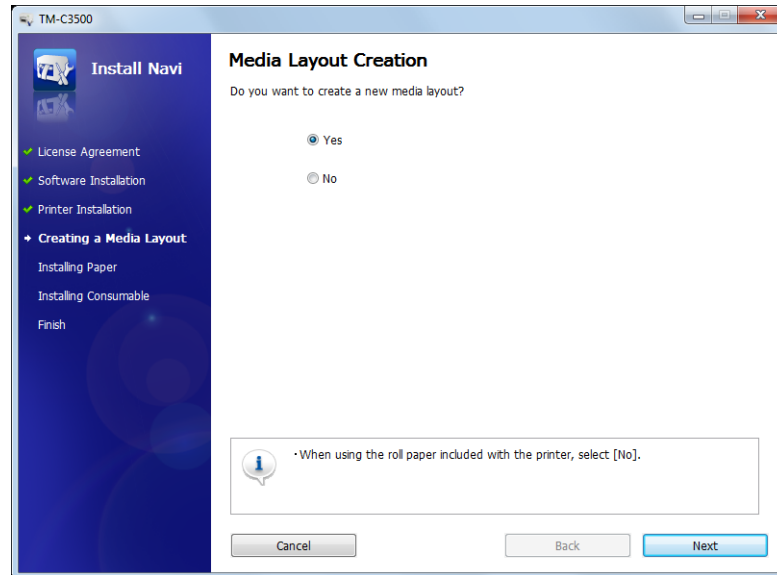

- 2 The following window appears.
Select either (Roll Paper) or (Fanfold Paper) and click (Next).

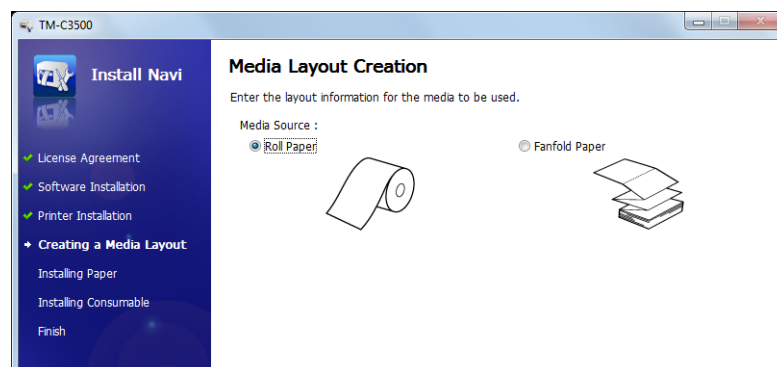

- 3** The following window appears.
Select the media to be used and click (Next).
When fanfold paper is selected, you can select [Die-cut label (Gap)], [Die-cut label (Blackmark)], [Continuous paper (Blackmark)], or [Transparent die-cut label (Gap)].

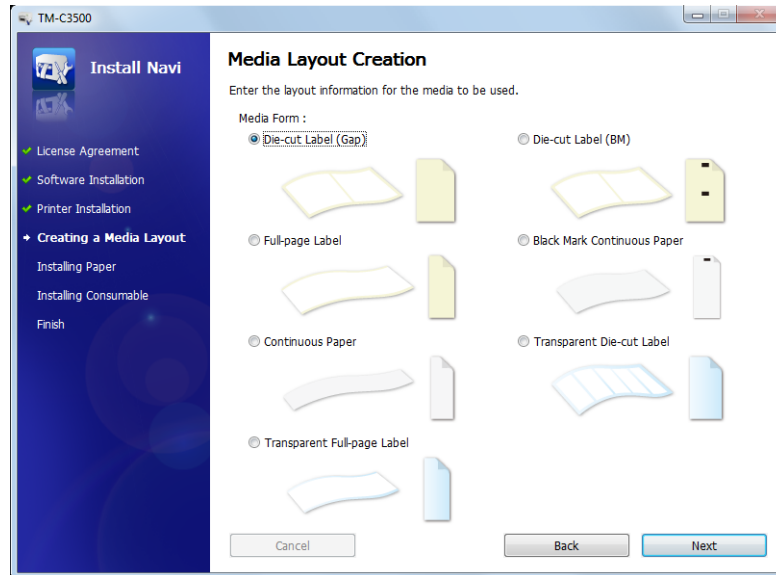

4 The following window appears. Enter each item and click (Next).

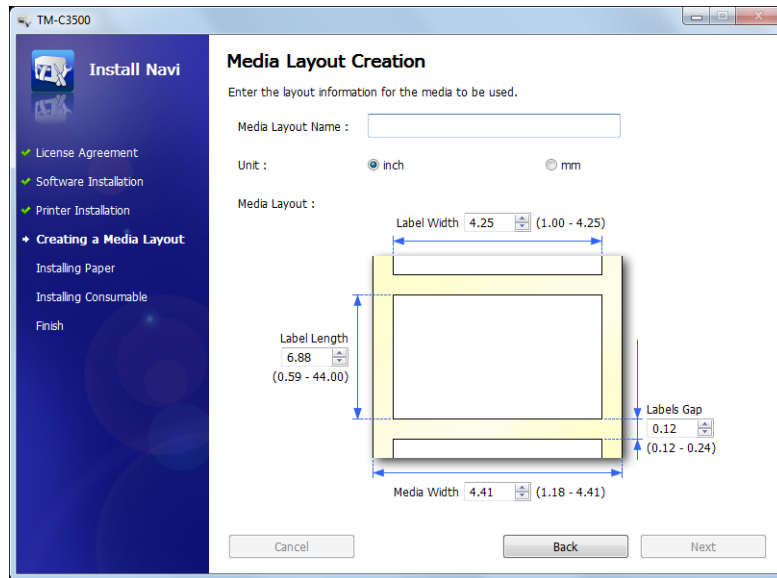

| Item | Description |
|-------------------|---|
| Media Layout Name | Enter any name. |
| Unit | Select the unit. |
| Media Layout | Enter the width and length of the media to be used. The information to be entered is different depending on the media type selected in Step 3. |

5 The following window appears. Enter each item and click (Next).

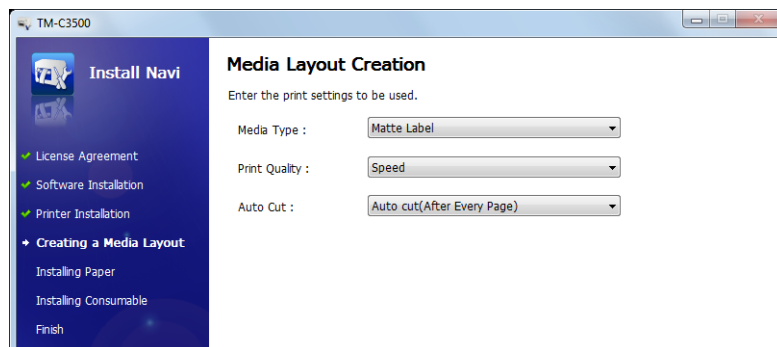

| Item | Description |
|---------------|---|
| Media Type | Select the media type. |
| Print Quality | Select the print quality. |
| Auto Cut | Select whether to enable/disable autocut. |

- 6** "Confirming the Media Layout" screen appears.
The newly set media layout information is displayed. Confirm the settings and click (Next).

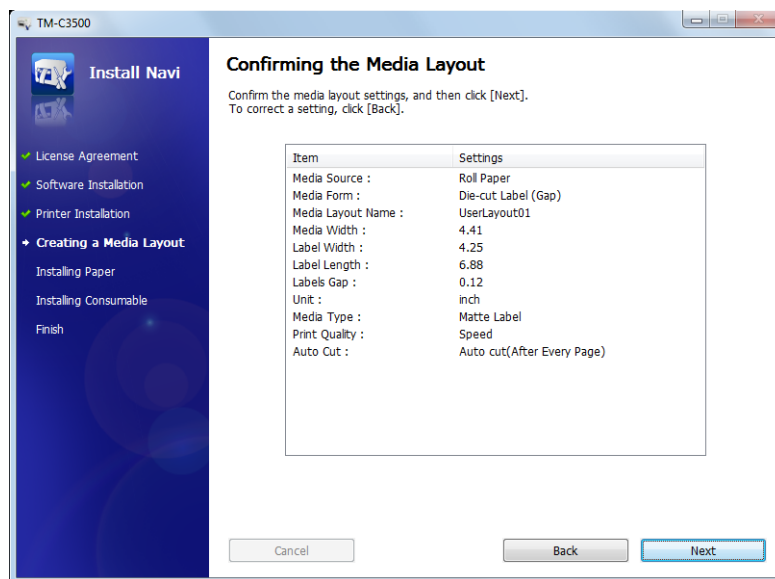

- 7** "Restarting the Printer" screen appears.
Restart the printer to apply the new settings.

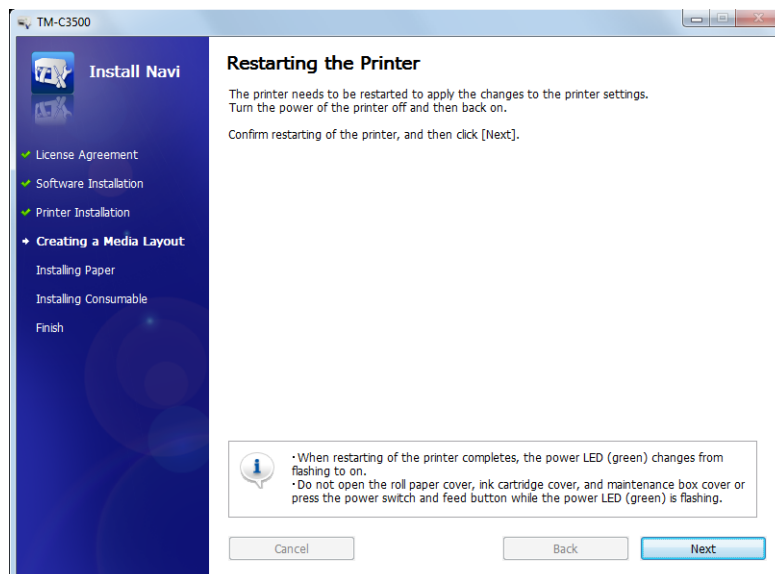

Shutter Adjustment

- 1 Turn the printer OFF.
- 2 Press down the release lever, and pull it to the front to open the roll paper cover.

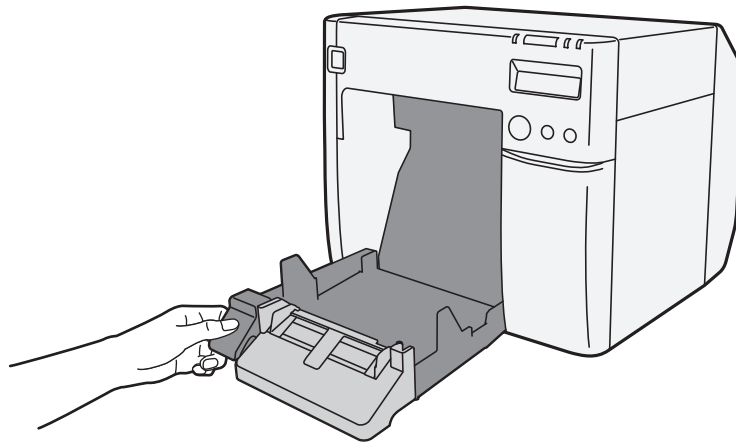

- 3 Refer to the shutter adjustment method label on the top of the printer, and open or close the shutters on the platen to match the width of the paper. If the shutter is set incorrectly, paper may be jammed or get dirty.

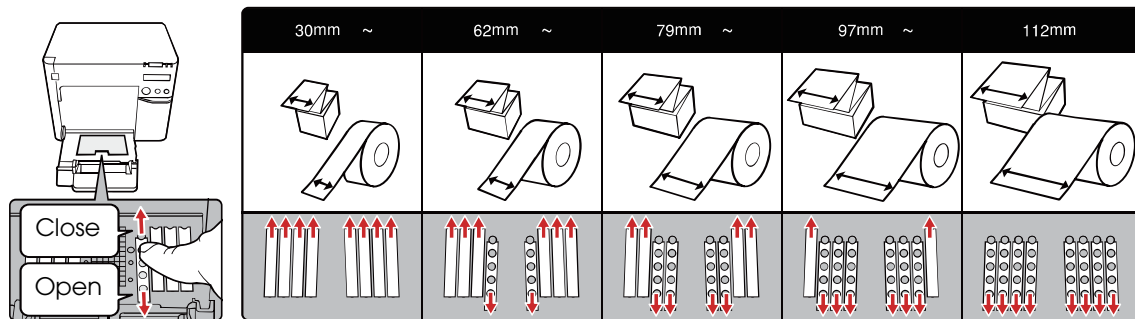

| Paper/backing width (mm) | Shutter open/close status |
|--|---|
| 30 mm {1.18"} or more, less than 62 mm {2.44"}} | Close all shutters. |
| 62 mm {2.44"} or more, less than 79 mm {3.11"}} | Open only the most inward shutters. |
| 79 mm {3.11"} or more, less than 97 mm {3.82"}} | Open only the 2 most inward shutter rows. |
| 97 mm {3.82"} or more, less than 112 mm {4.41"}} | Open only the 3 most inward shutter rows. |
| 112 mm {4.41"}} | Open all shutters. |

- 4 Close the roll paper cover.

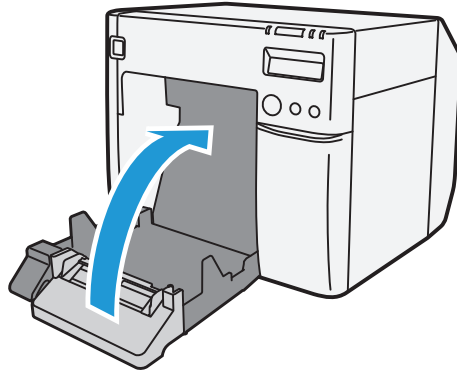

Ejection Angle of Printed Paper

Make sure paper is ejected straight from the paper ejection guides, as shown in the illustration. If paper is not ejected straight due to such causes as an obstruction, the print result may be distorted.

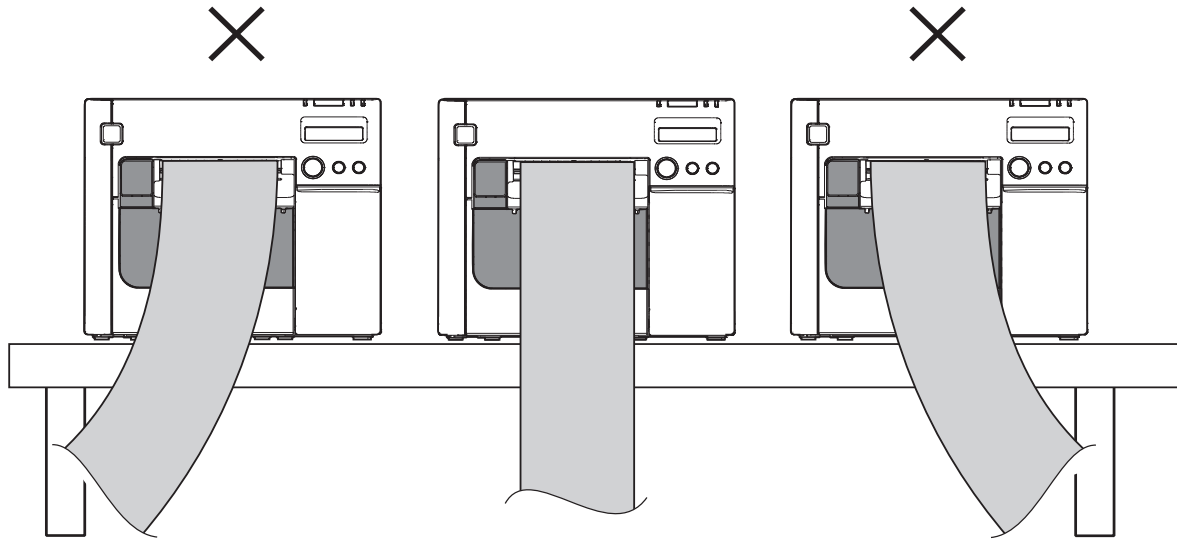

How to Display the Printer Driver

- 1 Open the (Devices and Printers).
 - For Windows 10:
Right click **(Start)** - **(Control Panel)** - **(Hardware and Sound)** - **(Devices and Printers)**.
 - For Windows 8.1/Windows 8:
Select **(Control Panel)** of Sidebar **(Settings)** on **(Desktop)**, and click **(Hardware and Sound)**, then **(Devices and Printers)**.
 - For Windows 7:
Click **(View devices and printers)** of **(Control Panel)** on **(Start)** menu.
 - For Windows Vista:
Click **(Printers)** of **(Control Panel)** on **(Start)** menu.
 - For Windows XP Professional:
Click **(Printers and Faxes)** on **(Start)** menu.
 - For Windows XP Home Edition:
Click **(Control Panel)** on **(Start)** menu, and click **(Printers and Faxes)**.
 - For Windows 2000:
Click **(Settings)** on **(Start)** menu, and click **(Control Panel)**.
 - For Windows Server 2003 R2:
Click **(Printers and Faxes)** on **(Start)** menu.

- 2** Right-click (**EPSON TM-C3500**), and click (**Printing Preferences**).
The printer driver screen is displayed.

NOTE

The barcode printing position is moved based on the amount of margin.

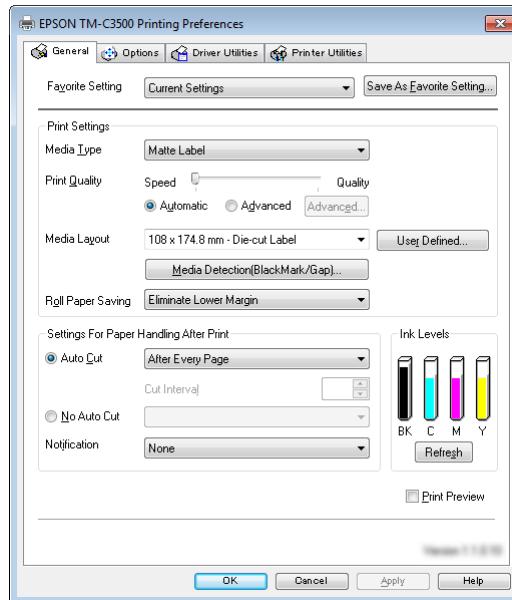

Registering the Media Layout

If the paper size to use is not in Media Layout, register the user defined media.
The registered layout will be stored in (Favorite Setting) to use from application of users.
(For details on how to register the favorite setting, see [Favorite Setting on page 83.](#))

- 1 Display the printer driver window.
(See [How to Display the Printer Driver on page 43.](#))
- 2 From (Print Settings), click (User Defined...).
"User Defined Media Layout" screen appears.
- 3 Enter Media Layout Name. This is User Defined Media.
If there is an existing defined media layout, you can create a new layout based on the defined media layout.
- 4 Select (Media Type).
- 5 Enter the size of the paper (unit: mm).

NOTE

To extend the printable area, selecting [Borderless Printing] will set no margins.
When the margin is zero, printing may occur out of the paper/label. Use this option according to the usage.

- 6 Click (Save). User Defined Media will be registered and displayed on the list of (Defined Media Layout).

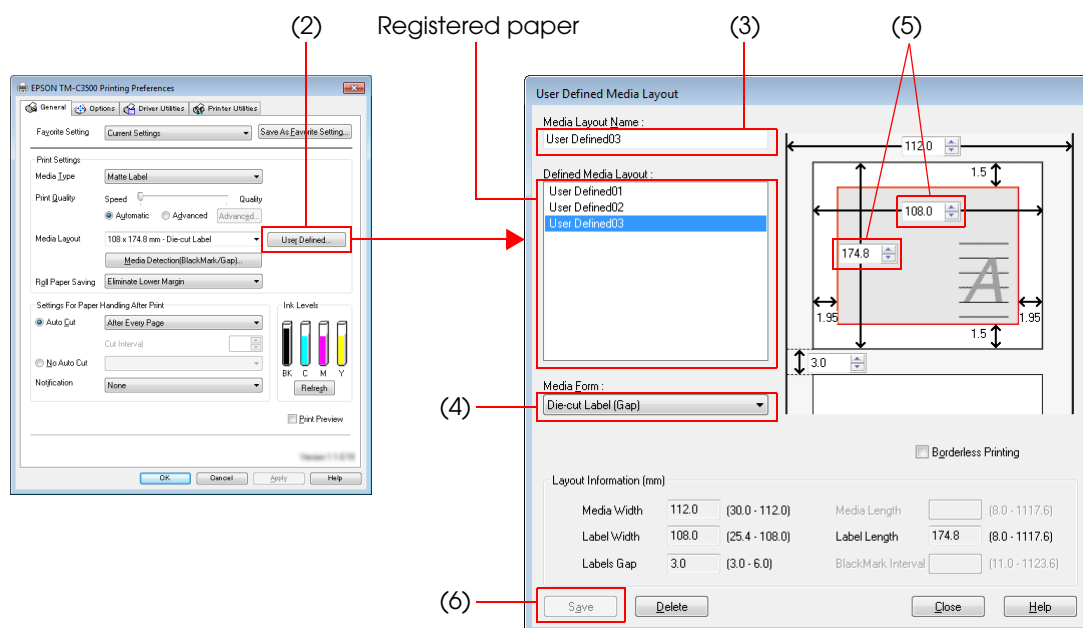

Attaching the Paper Ejection Tray

If you attach the paper ejection tray, you can temporarily store the printed paper in the tray. Follow the steps below to install/adjust the ejection tray.

CAUTION

- Paper may not stay in the paper ejection tray depending on the paper curl and length.
- When the fanfold paper is used, the several printed papers can be stored in the ejection tray. See [Paper Ejection Tray on page 230](#) for the numbers of the fanfold paper that can be stored in the ejection tray.

- 1 Attach the paper ejection tray to the hooks under the paper ejection table.

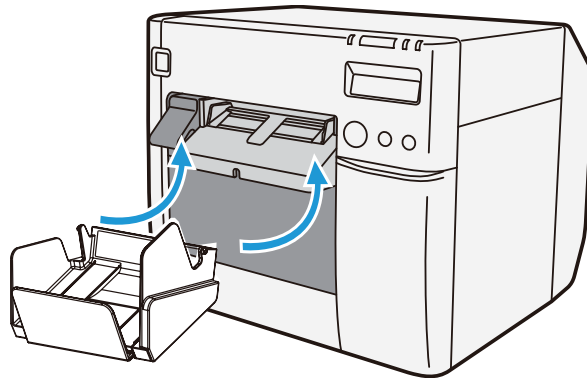

- 2 Pull the lever at the bottom-right of the paper ejection tray to unlock it.

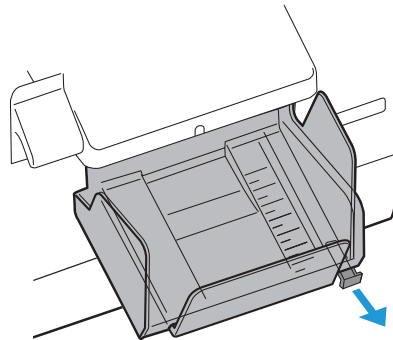

- 3** Slide the bottom tray to align it with the paper length.

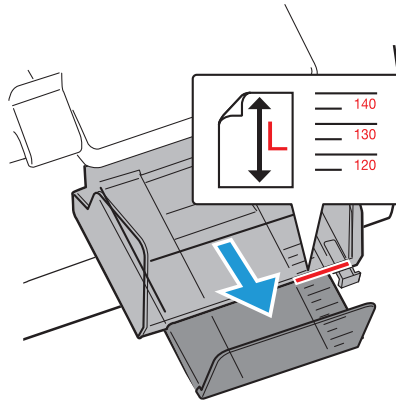

- 4** Pull up the lever at the bottom-right of the paper ejection tray to lock it.

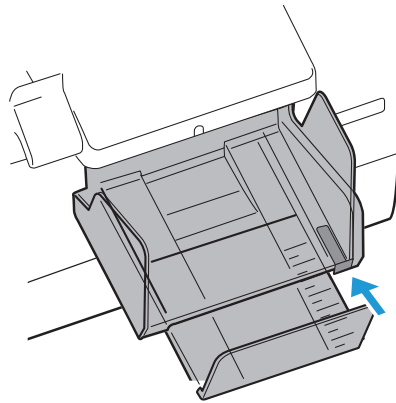

Setting the DIP Switches

Change the DIP switch settings in the following cases.

- When attaching the power switch cover to prevent the power switch from being pressed
- When changing the LCD display language
- When changing the volume of the buzzer

Setting Procedure

Follow the steps below to change the DIP switch settings.



Turn the power off before removing the DIP switch cover.
Otherwise, a short-circuit may cause the printer to malfunction.

CAUTION

DIP switch setting becomes enabled after turning the power on or completing reset by the interface.

- 1** Make sure the power supply for the printer is turned OFF.
- 2** Open the ink cartridge cover and remove the DIP switch cover.

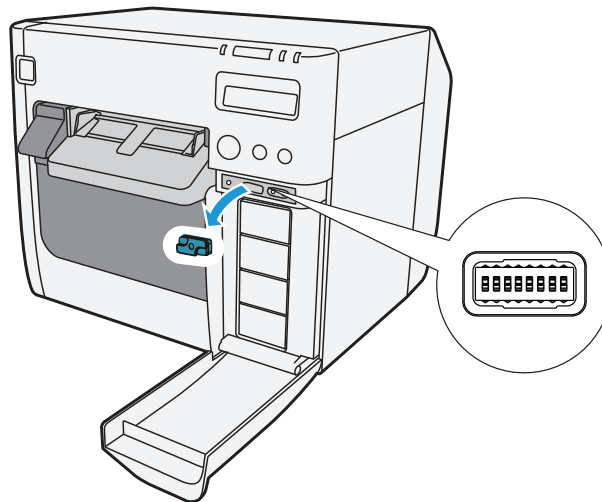

- 3** Set the DIP switches, using the tip of a tool, such as a small screwdriver.
- 4** Attach the DIP switch cover, and close the ink cartridge cover.

Function of the DIP Switches

| SW | Function | ON | OFF | Factory settings |
|----|-------------------------------|------------------------------|--------------|------------------|
| 1 | Operation of the power switch | Reset | Power ON/OFF | OFF |
| 2 | Internal use | Fixed to OFF (Do not change) | | OFF |
| 4 | Internal use | Fixed to OFF (Do not change) | | OFF |
| 5 | LCD display language settings | See the table below | | OFF |
| 6 | | | | OFF |
| 7 | | | | OFF |
| 8 | Buzzer volume | High | Low | OFF |

CAUTION

When attaching the power switch cover to prevent the power switch to be pressed, set DIP switch 1 to ON.

LCD display language settings

| Switch No. | | | Language settings |
|------------|-----|-----|-------------------|
| 5 | 6 | 7 | |
| OFF | OFF | OFF | Japanese (Kana) |
| OFF | OFF | ON | English |
| OFF | ON | OFF | French |
| OFF | ON | ON | Italian |
| ON | OFF | OFF | German |
| ON | OFF | ON | Spanish |
| ON | ON | OFF | Portuguese |
| ON | ON | ON | Dutch |

Setting the Printer Driver

In addition to the printing preferences, the printer driver also provides the printer settings and various utility functions.

- Banding Reduction
- TM-C3500 PrinterSetting
- Setting for EPSON Status Monitor 3

Banding Reduction

You can reduce banding (extraneous lines in printing) to obtain better print quality. This function, however, lowers the print speed.

Follow the steps below to reduce banding.

- 1 Display the printer driver window.
(See [How to Display the Printer Driver on page 43.](#))
- 2 On "General" window, select (Advanced) under (Print Settings). Then click (Advanced...).

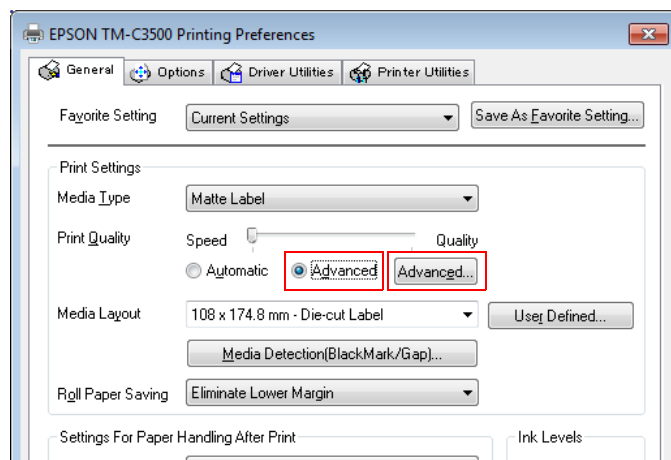

- 3 "Advanced" screen appears. Check (Banding Reduction), and click (Close).

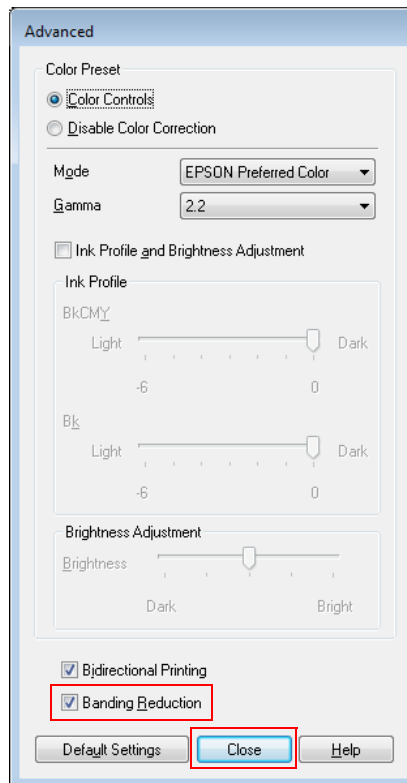

- 4 The screen returns to "General" window. Click (OK).

TM-C3500 PrinterSetting

TM-C3500 PrinterSetting is used to change various printer settings.

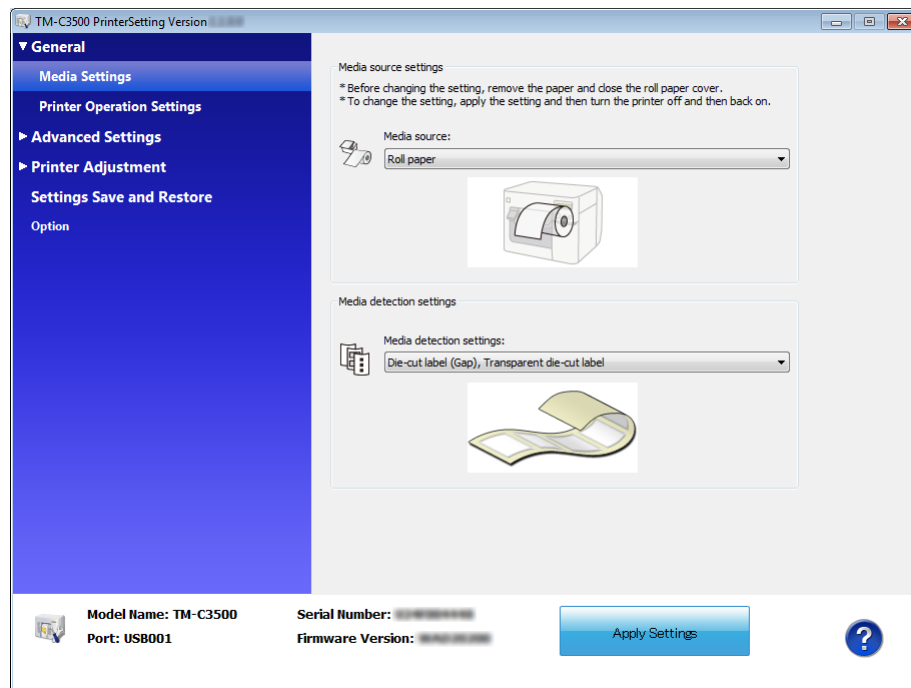

From TM-C3500 PrinterSetting, you can change the following printer settings:

| Item | | Description |
|--------------------------|----------------------------|---|
| General | Media source settings | <ul style="list-style-type: none"> • Media source settings • Media detection settings |
| | Printer Operation Settings | <ul style="list-style-type: none"> • Nozzle Check Mode • Paper Loading Settings |
| Advanced | Notification Settings | <ul style="list-style-type: none"> • Beep Notification Setting at an Error • LED Notification Setting at Ink Low • Notification Setting at a Media Size Error |
| | Panel Button Settings | <ul style="list-style-type: none"> • Enable/Disable the Feed Button • Enable/Disable the Cut Button • Enable/Disable the Cleaning Button |
| | Operating Time Settings | <ul style="list-style-type: none"> • Platen Vacuum Operation Pause Time Settings • Data Standby Time Settings |
| Printer Adjustment | Paper Feed Adjustment | <ul style="list-style-type: none"> • Cut Position Adjustment • Print Start Position Adjustment (Vertical Direction) • Print Start Position Adjustment (Horizontal Direction) |
| | Sensor Adjustment | <ul style="list-style-type: none"> • Adjust the Label Gap Detection Sensor • Adjust the Black Mark Detection Sensor |
| | Print Head Alignment | <ul style="list-style-type: none"> • Banding Adjustment • Bidirectional Printing Adjustment |
| Setting Save and Restore | | Save the printer settings to the backup file and apply the settings in the backup file to the printer. |
| Option | | <ul style="list-style-type: none"> • Media source Settings Option |

Setting EPSON Status Monitor 3

When EPSON Status Monitor 3 is used, the paper type and the ink level are displayed on a pop-up window when printing. In addition, when a fatal error occurs, an error window is displayed.

[Not use] is set by default setting; however, if a fatal error occurs, an error window can be displayed.

Use/Not use EPSON Status Monitor 3

[Not use EPSON Status Monitor 3] is set by default setting. [Notification Settings for Fatal Errors] is displayed on the EPSON Status Monitor 3 Settings window in Driver Utilities.

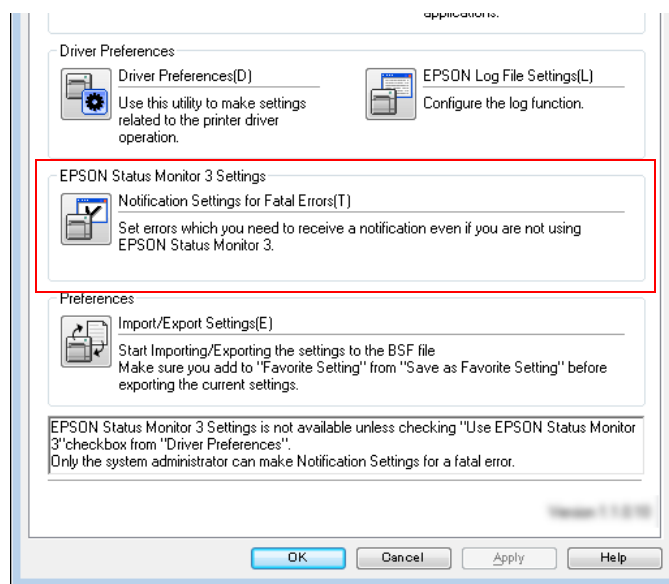

Follow the steps below to change to [Use EPSON Status Monitor 3].

- 1 Turn the printer ON.
- 2 Display the printer driver window.
(See [How to Display the Printer Driver](#) on page 43.)
- 3 Select (Driver Utilities) tab and click (Driver Preferences) under (Driver Preferences).
- 4 The (Driver Preferences) window is displayed.
Check the box of (Use EPSON Status Monitor 3) and click (OK).

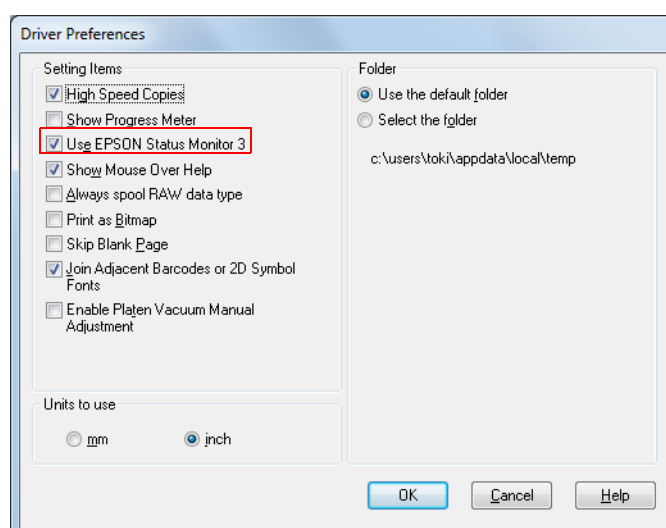

- 5 (EPSON Status Monitor 3) and (Monitoring Preferences) are displayed in (EPSON Status Monitor 3 Settings) on the Driver Utilities window.

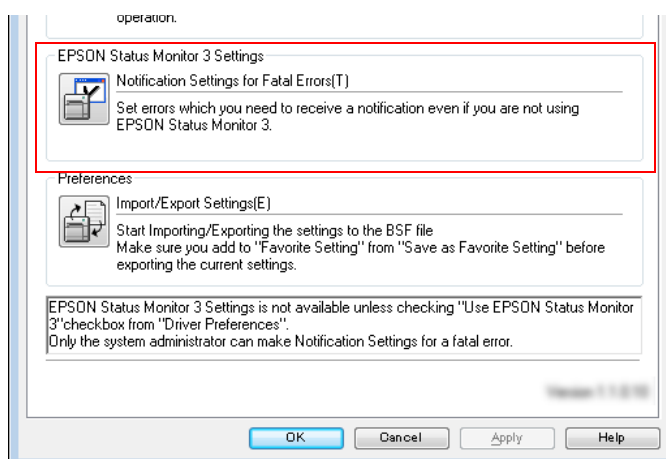

Use EPSON Status Monitor 3

When [Use EPSON Status Monitor 3] is set, the following operations will be performed:

- When printing, a window automatically appears, allowing you to check the printer status and the ink level.
- Error information is displayed when an error occurs during printing.
The EPSON Status Monitor 3 will not be activated if an error occurs when not printing.
- Clicking the icon for [EPSON Status Monitor 3] on the task tray allows you to display [EPSON Status Monitor 3] at any time.
(See [Displaying the icon on page 60](#) for how to display the icon.)

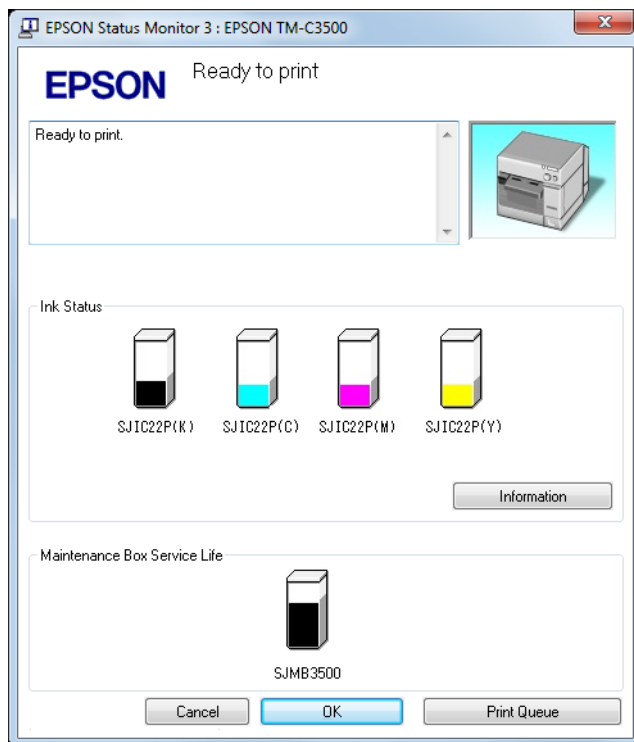

Display window for EPSON Status Monitor 3



Icon on task tray

- The following items can be set in [Monitoring preferences].
Selecting error indications:
(See [Error notification setting for \[Not use EPSON Status Monitor 3\]](#) on page 58.)
Displaying the [EPSON Status Monitor 3] icon on the task bar:
(See [Displaying the icon on page 60.](#))

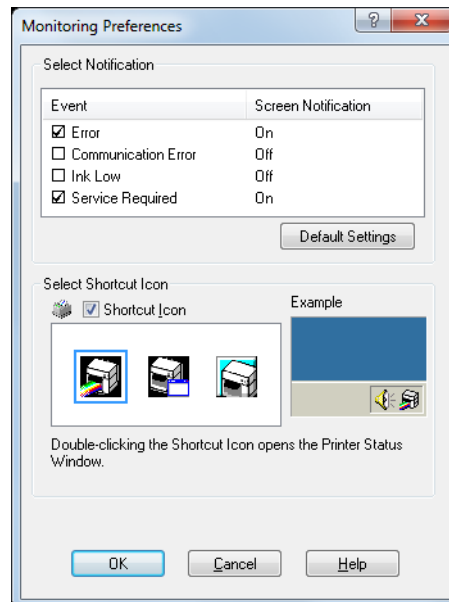

Error notification setting for (Not use EPSON Status Monitor 3)

Follow the steps below to set error notification for [Not use EPSON Status Monitor 3].

- 1 Turn the printer on.
- 2 Display the printer driver window.
(See [How to Display the Printer Driver on page 43.](#))
- 3 Select (Driver Utilities) tab and click (Driver Preferences).
When EPSON Status Monitor 3 is enabled, [Notification Settings for Fatal Errors] is not displayed. (Disable EPSON Status Monitor 3 by referring to [Use/Not use EPSON Status Monitor 3 on page 54.](#))
- 4 The (Notification Settings for Fatal Errors) window is displayed. Select the items you want to display when an error occurs, and click (OK).

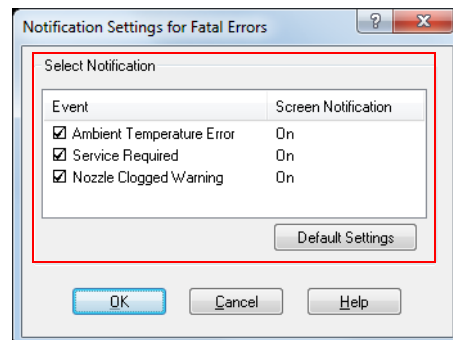

- Ambient Temperature Error: When the printer temperature is high
(Default: Screen Notification [On])
- Service Required: When a no-print error or service-required error occurs
(Default: Screen Notification [On])
- Nozzle Clogged Warning: When the nozzle is clogged
(Default: Screen Notification [On])

Error notification setting for (Use EPSON Status Monitor 3)

Follow the steps below to set error notification for [Use EPSON Status Monitor 3].

- 1** Turn the printer ON.
- 2** Display the printer driver window.
(See [How to Display the Printer Driver on page 43.](#))
- 3** Select (Driver Utilities) tab and click (Monitoring Preferences).
When EPSON Status Monitor 3 is disabled, the [Monitoring Preferences] is not displayed.
(Enable EPSON Status Monitor 3 by referring to [Use/Not use EPSON Status Monitor 3 on page 54.](#))
- 4** The (Monitoring Preferences) window is displayed. Click on the box of your choice, and click (OK).

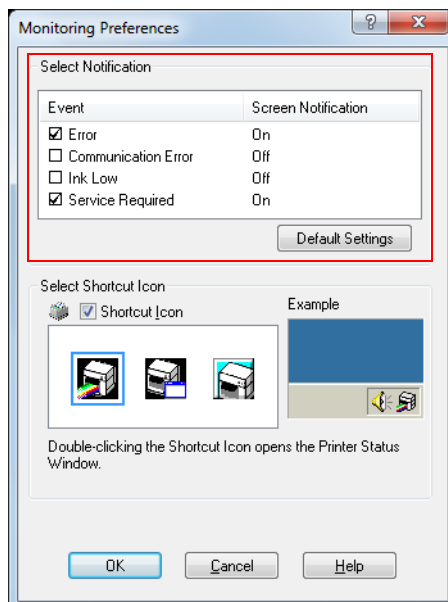

- Error: When paper/ink replacement is required
(Default: Screen Notification [On])
- Communication Error: When the printer power is off
(Default: Screen Notification [Off])
- Ink Low: When the ink amount is low
(Default: Screen Notification [Off])
- Service Required: When a printer error occurs
(Default: Screen Notification [On])

Displaying the icon

Keeps icon on the task tray so that user can check as needed. The icon is not displayed when default setting. Follow the steps below to display the icon.

- 1 Turn the printer ON.
- 2 Display the printer driver window.
(See [How to Display the Printer Driver on page 43.](#))
- 3 Select (Driver Utilities) tab and click (Monitoring Preferences).
- 4 The (Monitoring Preferences) window is displayed. Check the box of (Shortcut Icon) and select the icon to display on the task bar. Click (OK).

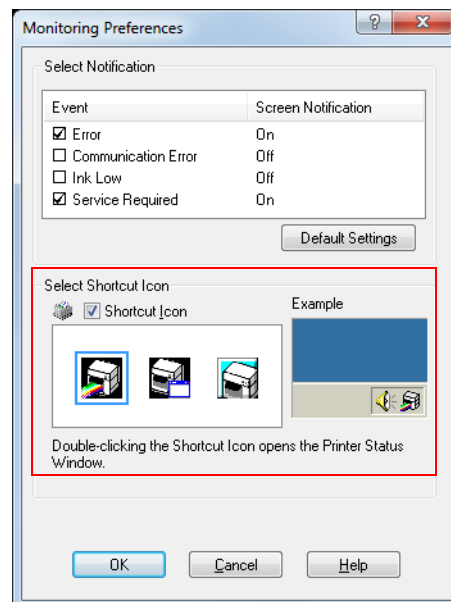

Handling

This chapter describes basic handling of the printer.

Replacing the Ink Cartridge

When the ink ends, the INK LED lights. Follow the steps below to replace the ink cartridge.

- 1 Turn the power on and make sure that the INK LED lights.
- 2 Pull down the ink cartridge cover to the front to open it.

CAUTION

Open the ink cartridge cover, and wait at least 4 seconds until internal operations stop. If you take out the ink cartridge in less than 4 seconds, there is a risk that the ink may spurt out.

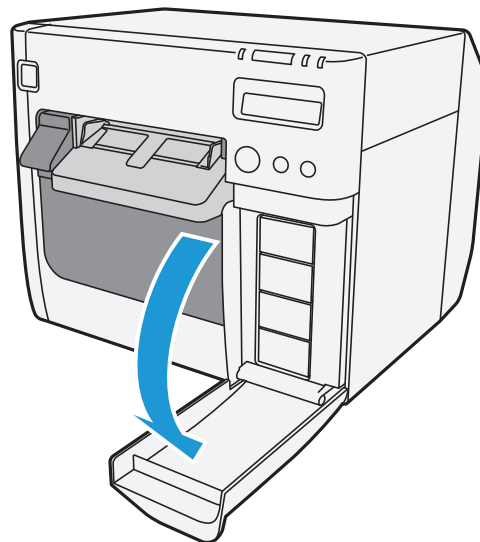

- 3 If there is a used ink cartridge that requires replacement, slowly push the ink cartridge, check that the lock is released, and pull the ink cartridge out towards you.
- 4 Shake new ink cartridge package 4 or 5 times before opening it and take out the ink cartridge from the package.

NOTE

Do not shake the ink cartridge too hard. The ink cartridge may leak if you shake it around too much or push the sides strongly.

- 5** With the label facing upwards, insert the new ink cartridge, and push it in slowly until it clicks into place.

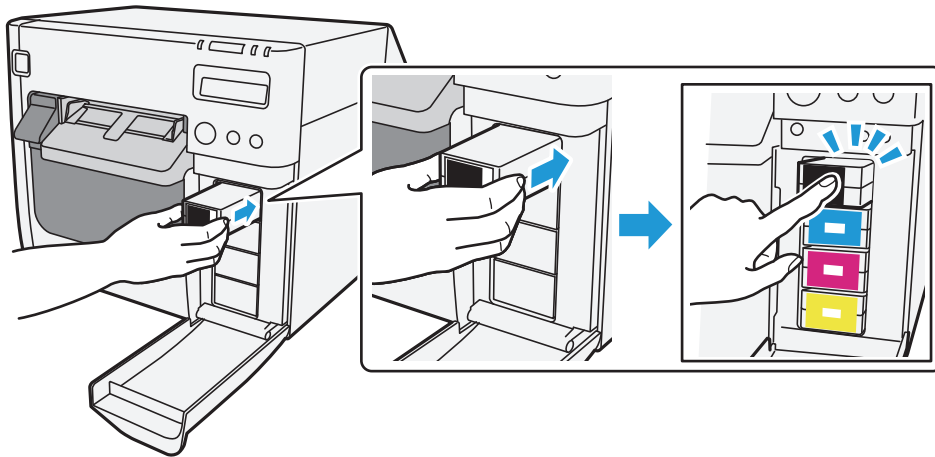

- 6** Close the ink cartridge cover.
- 7** When the ink cartridge replacement is completed, the INK LED turns off, and printing can be performed.

Cautions on using ink cartridges

- ❑ Do not touch the IC chip on the cartridge. Doing so may cause operating/printing malfunction.
- ❑ This product uses ink cartridges equipped with an IC chip that monitors the amount of ink used by each cartridge. Cartridges are usable even if they are removed and reinstalled. However, if an ink cartridge in which little amount of ink remains is removed and reinstalled, it may not be usable. Some ink is consumed each time cartridges are installed because the product automatically checks their reliability.
- ❑ Install all ink cartridges. Printing is not possible even if only one ink cartridge is missing.
- ❑ Since ink cartridges are designed to stop the operation before ink runs out completely to maintain the quality of the print head, some ink remains in the used ink cartridge.
- ❑ All the ink colors are consumed also for the maintenance operations when an ink cartridge is replaced and for print head cleaning.
- ❑ Even for monochrome printing, all the ink colors are used in an operation designed to maintain the printing and print head quality.
- ❑ Use of an old ink cartridge may result in reduced print quality. Use it up within six months after opening the package. The usage period for ink cartridges is printed on the packaging of individual ink cartridges.
- ❑ There may be some ink around the ink supply port on the removed ink cartridge. Take care so that it does not stain the desk or other surface.
- ❑ Do not remove the ink cartridge, except when you replace it.
- ❑ Do not open the ink cartridge package until you are ready to install it in the product.

- ❑ Do not allow foreign objects to fall into the cartridge installation section. Doing so may cause printer malfunction.
- ❑ When ink is charged for the first time (right after purchase), ink is consumed for filling the print head nozzle (ink discharge holes) to get ready for printing. That is why the number of the printable sheets may be fewer than for the cartridges to be installed later.
- ❑ Epson recommends the use of genuine Epson ink cartridges. For the best performance of the printer, it is recommended to use genuine Epson ink cartridges. Use of non-genuine Epson ink cartridges can adversely affect the printing quality and prevent the printer from realizing its maximum performance. Epson cannot guarantee the quality and reliability of non-genuine Epson products. Repairs for any damage or breakdown of this product due to the use of non-genuine Epson products will not be free of charge even if the warranty period is still valid.
- ❑ Color adjustment of the product is based on the use of genuine Epson ink cartridges. Use of non-genuine ink cartridges may result in reduced print quality. Use of genuine Epson ink cartridges is recommended.
- ❑ A cool and dark place is recommended to store ink cartridges.
- ❑ If the ink cartridge is stored in a cold place for a long period of time, let it warm up at least 3 hours before using it.
- ❑ If moving or transporting the product after the ink cartridges are installed, leave them installed during the moving or transporting process.

Replacing Maintenance Box

CAUTION

- Do not dismantle the Maintenance box.
- Do not touch the IC chip on the cartridge.
- Keep out of reach of children, and do not drink.
- Do not reuse a maintenance box which was removed and detached for a long period.
- When using the printer for the first time, the replacement interval for the maintenance box is shorter than usual as ink charging consumes the ink.

Follow the steps below to replace the maintenance box.

- 1** Turn the printer OFF.
- 2** Open the maintenance box cover towards you.

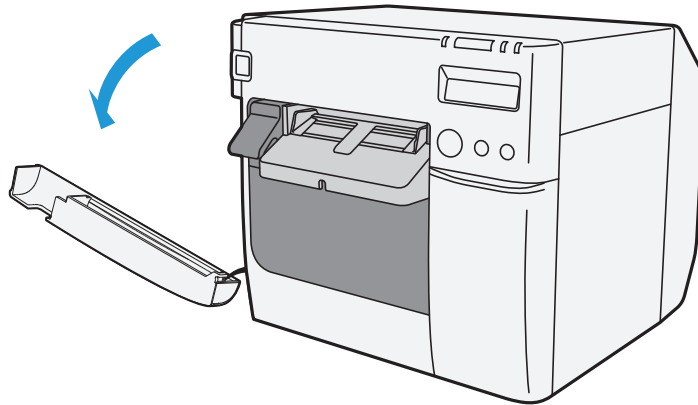

- 3** Pull out the used maintenance box towards you.

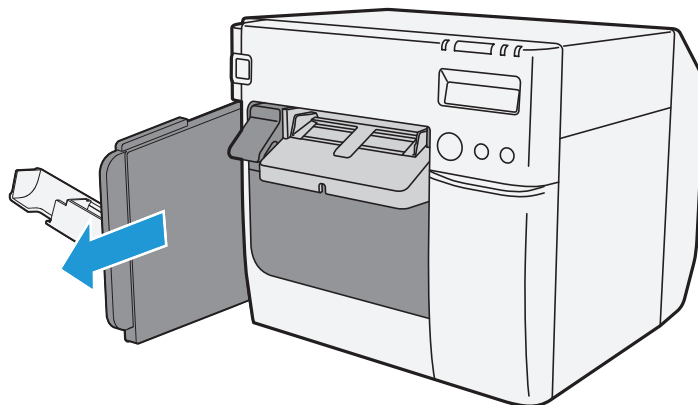

- 4** Put the maintenance box into the plastic bag for disposal of used maintenance box.

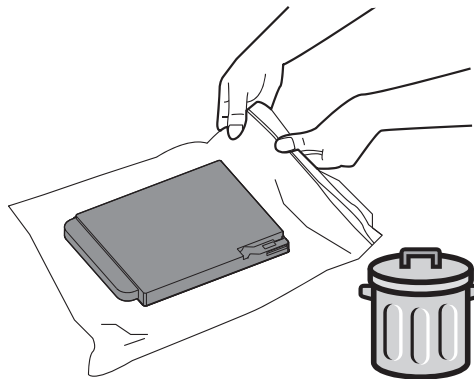

- 5** Slowly insert the new maintenance box.

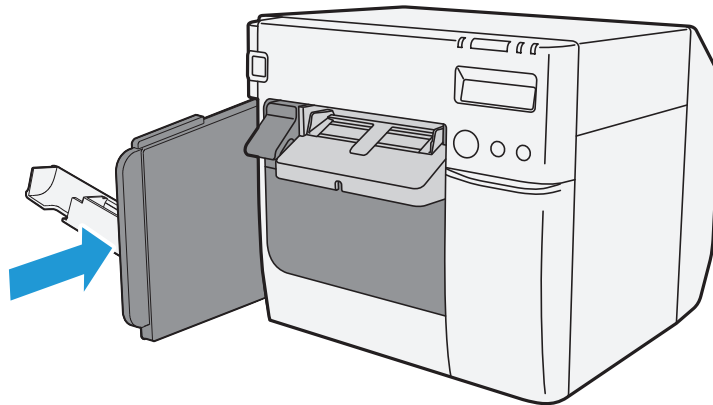

- 6** Close the maintenance box cover.

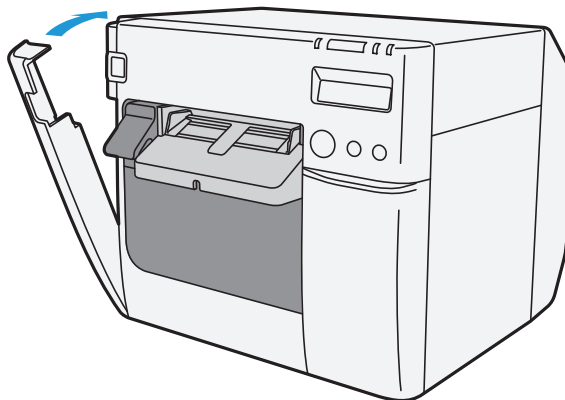
**NOTE**

After replacing the maintenance box, we recommend that you clean the platen.
(See the ["Cleaning the platen"](#) on page 162.)

Replacing Roll Paper with Fanfold Paper

Follow the steps below to replace the roll paper with fanfold paper.

- 1** Press down the release lever, and pull it to the front to open the roll paper cover.
Remove the used roll paper.

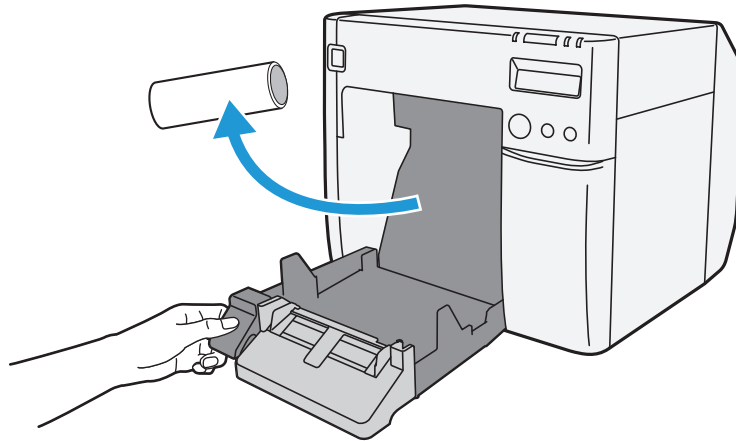

- 2** Turn the printer ON.
- 3** Display the printer driver window.
(See ["How to Display the Printer Driver"](#) on page 43.)
- 4** Display TM-C3500 PrinterSetting. Select (Printer Utilities) tab and click (Printer Preferences) - (Printer Setting Utility).

- 5** From TM-C3500 PrinterSetting, specify the media source and the media detection method. Then, click (Apply Settings).
After setting [Media source], set [Media detection settings].

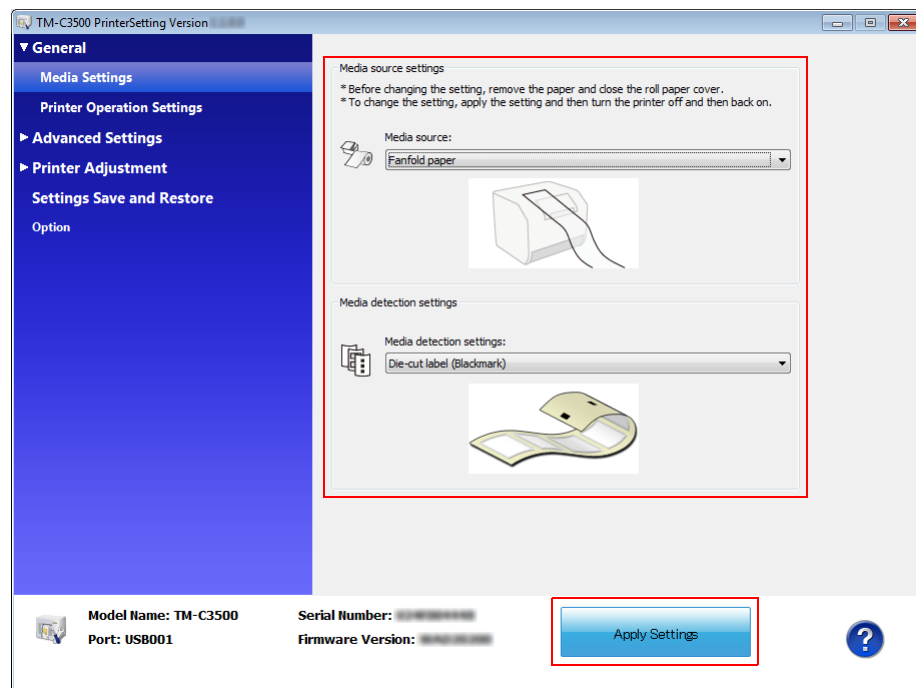

| Item | Description |
|--------------------------|--|
| Media source | Select (Fanfold paper). |
| Media detection settings | Select the media type. <ul style="list-style-type: none"> Die-cut label (Blackmark) Continuous paper (Blackmark) Die-cut label (Gap), Transparent die-cut label |

- 6** The confirmation window appears. Click (Yes) to send the settings to the printer.
- 7** The following window appears. Click (OK).

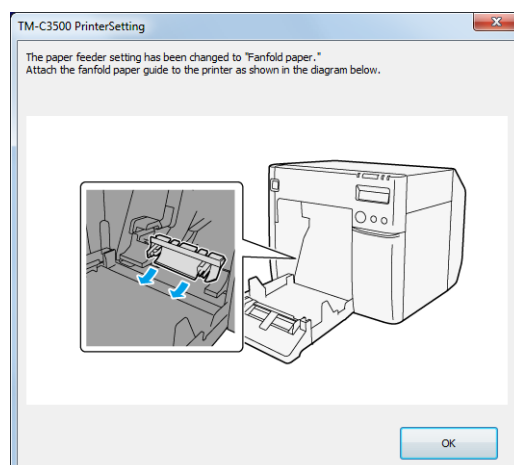

- 8 The completion window appears. Click (OK).
- 9 On the printer driver window, select (General) tab. Specify the media settings and click (OK).

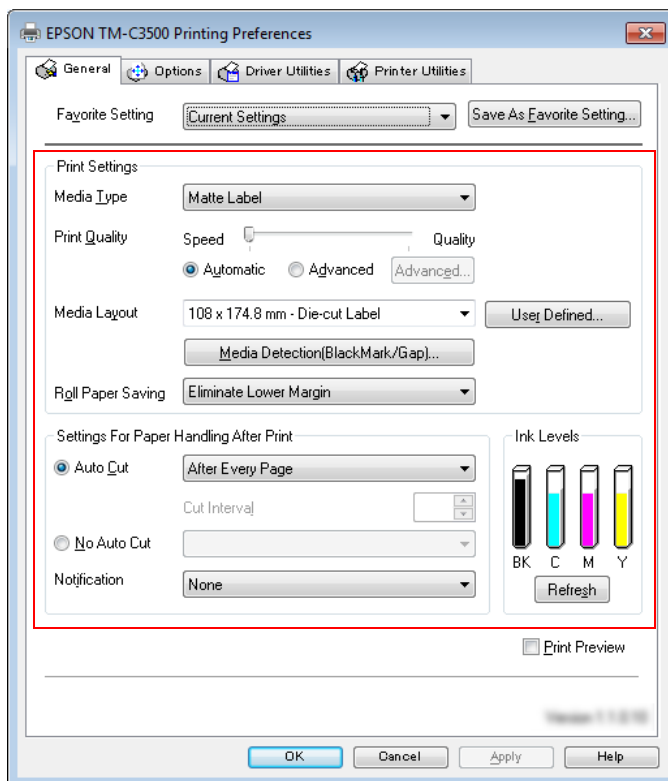

| Item | | Description |
|---|---------------|--|
| Print Settings | Media Type | Select the media type. |
| | Print Quality | Select the print quality. |
| | Media Layout | Select the media layout. If the media layout to be used is not included in the list, create a new layout. See the " Registering the Media Layout " on page 45. |
| Settings For Paper Handling After Print | Auto Cut | Select this to enable autotcut after printing. |
| | No Auto Cut | Select this to disable autotcut after printing. |

- 10 Turn the printer OFF.

CAUTION

Changes in the Media detection settings are saved in the memory in the printer when the printer is turned off.

- 11** Open the fanfold paper cover and take out the paper feed guide.

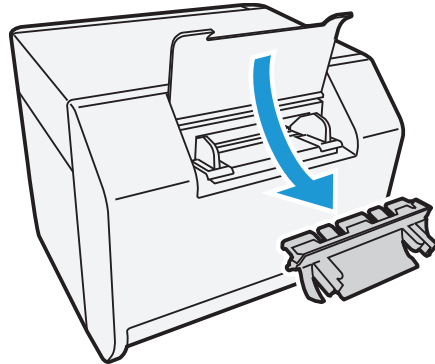

- 12** Pull the release lever to the front to open the roll paper cover.

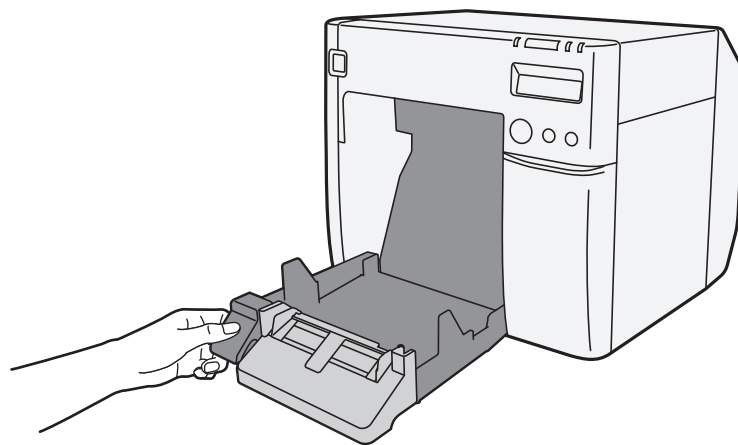

- 13** Insert the paper feed guide for fanfold paper into the groove inside the roll paper cover to install it.

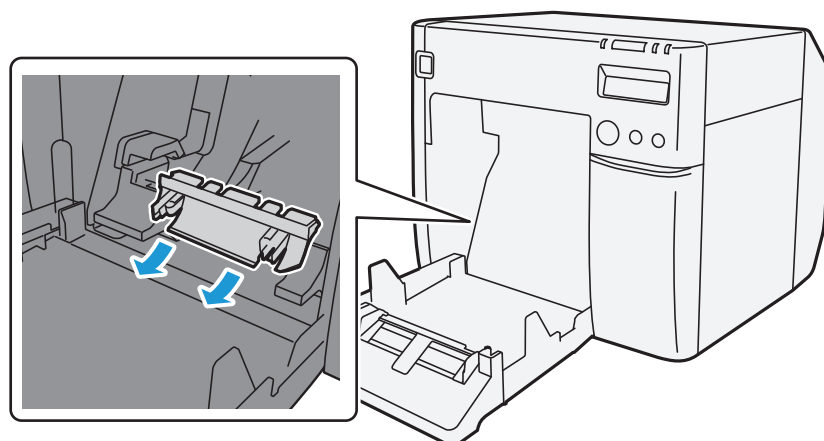

14 Refer to the shutter adjustment method label on the top of the printer, and open or close the shutters on the platen to match the width of the roll paper. If the shutter is set incorrectly, paper may be jammed or get dirty.

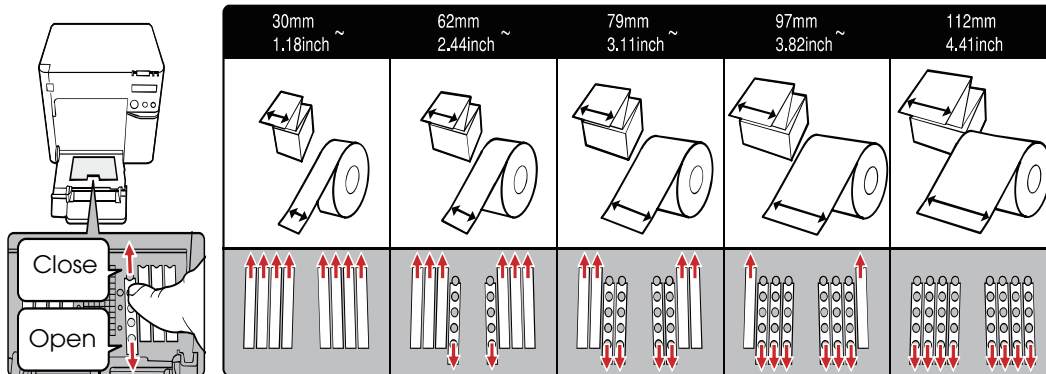

| Paper/backing width (mm) | Shutter open/close status |
|---|---|
| 30 mm {1.18"} or more, less than 62 mm {2.44"} | Close all shutters. |
| 62 mm {2.44"} or more, less than 79 mm {3.11"} | Open only the most inward shutters. |
| 79 mm {3.11"} or more, less than 97 mm {3.82"} | Open only the 2 most inward shutter rows. |
| 97 mm {3.82"} or more, less than 112 mm {4.41"} | Open only the 3 most inward shutter rows. |
| 112 mm {4.41"} | Open all shutters. |

15 Close the roll paper cover.

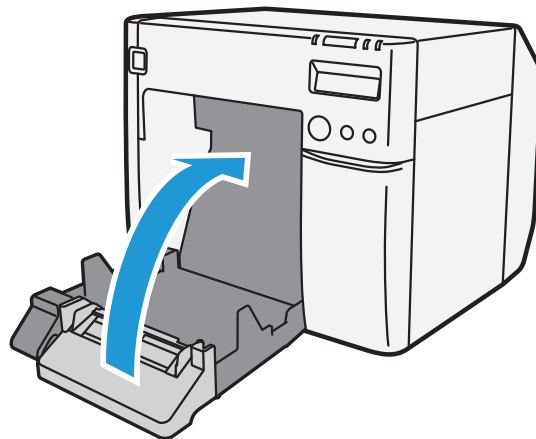

16 Release the lock of the paper ejection guide with a fine-tipped tool.

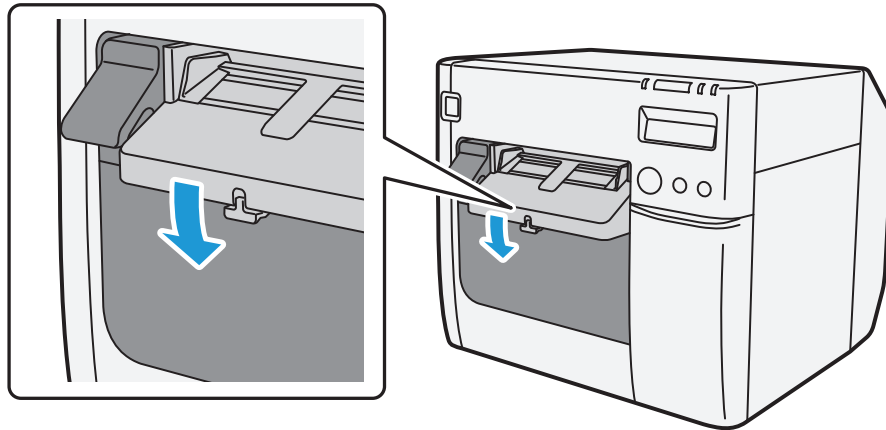

17 Slide the paper ejection guide to the very left end, and lock it.

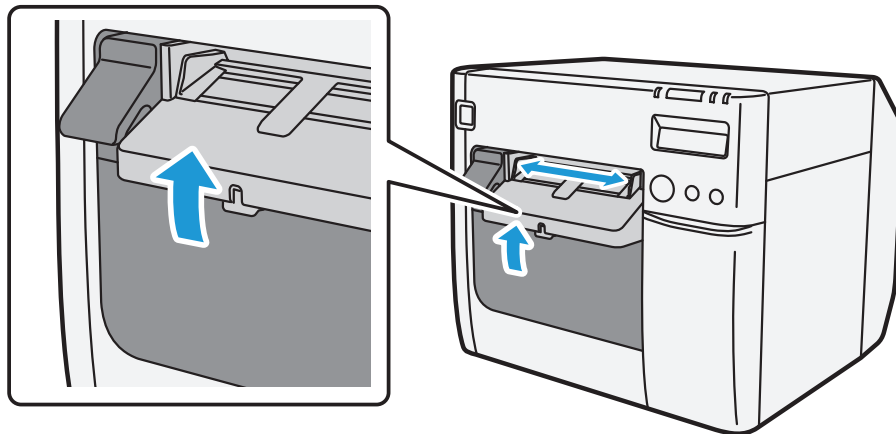

18 Open the cover at the back of the printer, and unlock the fanfold paper guide.

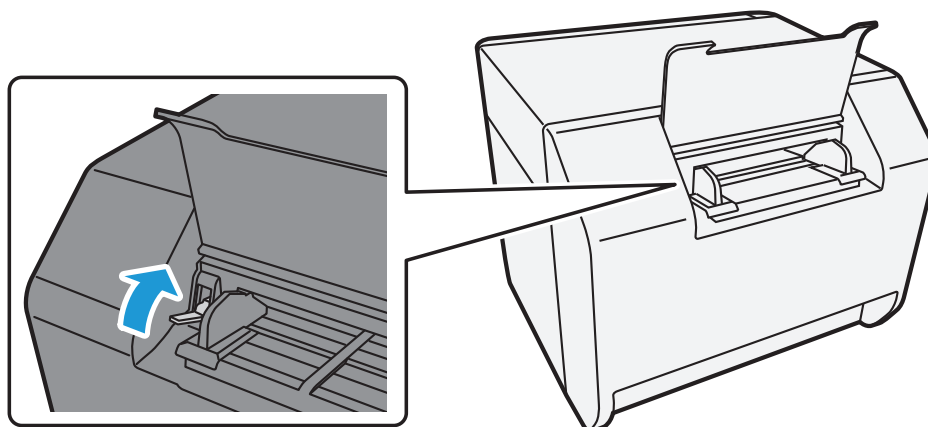

19 Adjust the fanfold paper guide to the fanfold paper width.

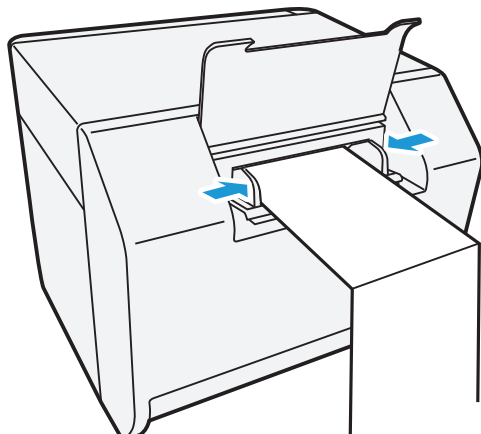

20 Lock the fanfold paper guide.

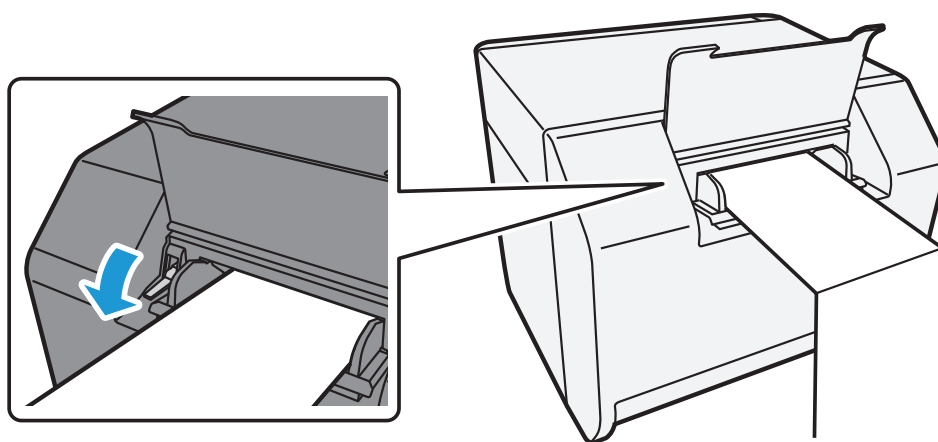

21 Turn the printer ON.

- 22** Insert the fanfold paper into the paper slot, facing the print surface upward. Insert the paper until it is pulled into inside the printer (approximately 100 mm {3.94"}). The printer detects the edge of the fanfold paper, pulls it inside, and then starts feeding it to the print starting position.

NOTE

When "Paper loading at roll paper cover close" is set to "With cutting", the paper is automatically cut after fed. (See "Paper Loading Settings" on page 119.)

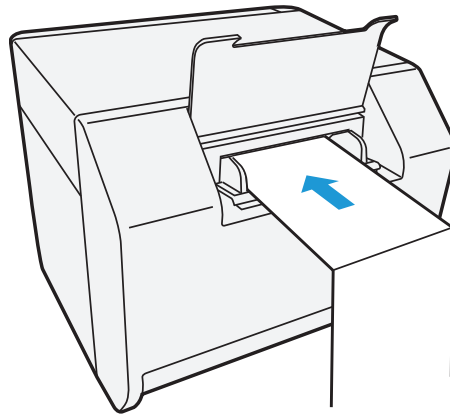

- 23** Place the stack of fanfold paper straight at least 40 mm {1.57"} away from the back of the printer.

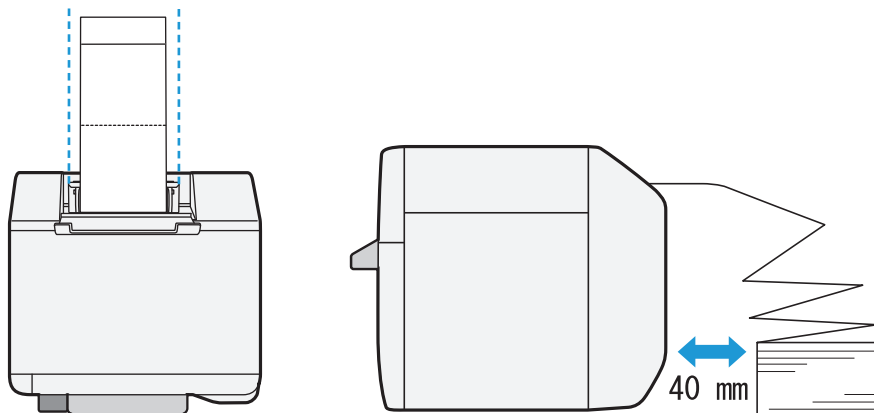

24 Close the fanfold paper cover.

CAUTION

- To prevent liquid and dust from getting into the printer, keep the fanfold paper cover closed when using the printer.
- To prevent paper jams from occurring, insert fanfold paper into the fanfold paper slot on the back of the printer with the roll paper cover closed.

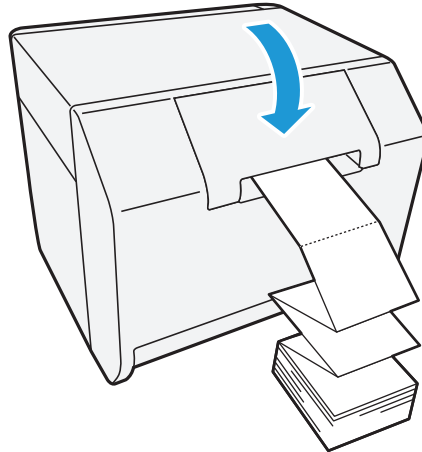

25 Confirm that the LCD displays an "F".

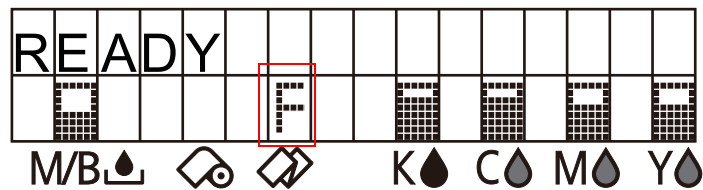

This is the end of loading of the fanfold paper.

Replacing Fanfold Paper with Roll Paper

Follow the steps below to replace the fanfold paper with roll paper.

- 1 Open the fanfold paper cover at the back of the printer.

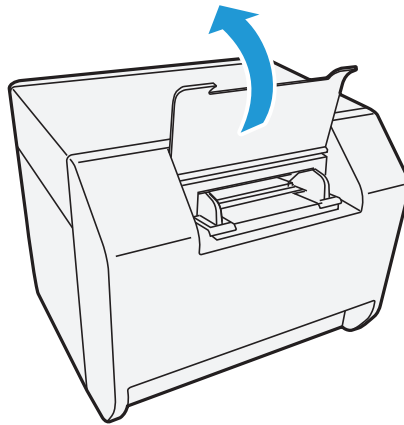

- 2 Remove the used fanfold paper.

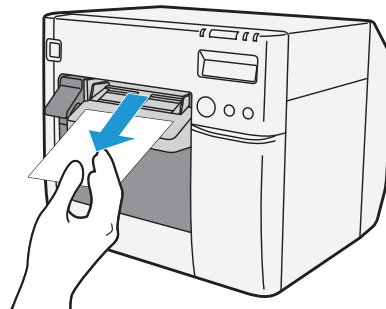
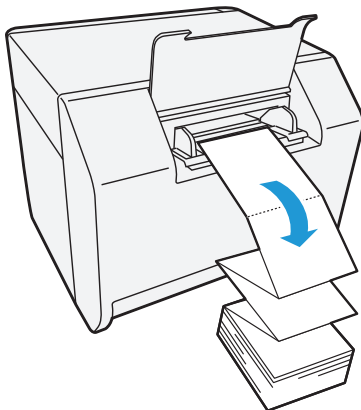

- 3 Turn the printer ON.
- 4 Display the printer driver window.
(See ["How to Display the Printer Driver"](#) on page 43.)
- 5 Display TM-C3500 PrinterSetting. Select (Printer Utilities) tab and click (Printer Preferences) - (Printer Setting Utility).

- 6 From TM-C3500 PrinterSetting, specify the media source and the media detection method. Then, click (Apply Settings).
After setting [Media source], set [Media detection settings].

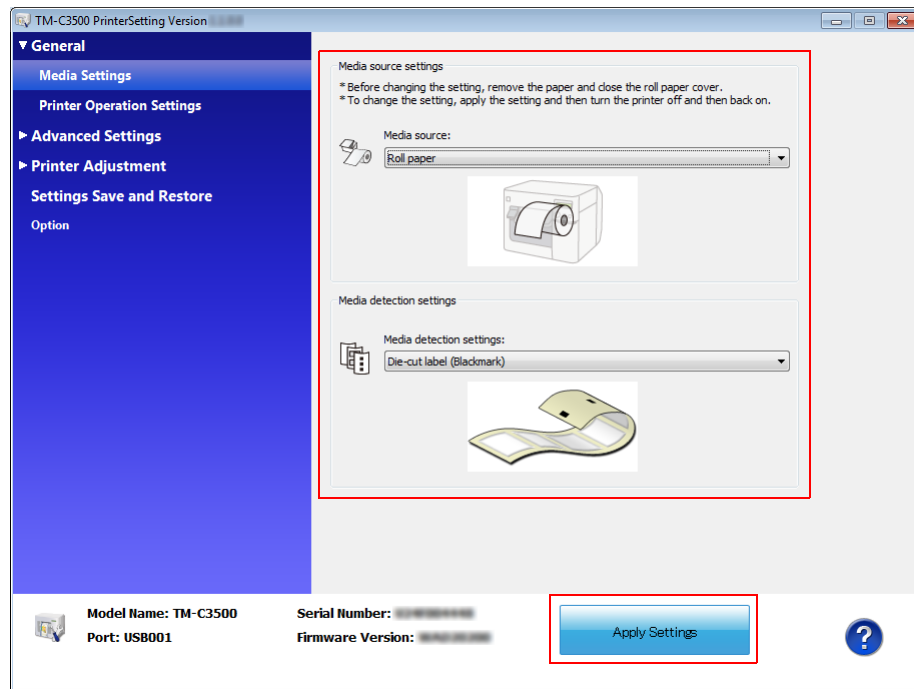

| Item | Description |
|--------------------------|--|
| Media source | Select (Roll paper). |
| Media detection settings | Select the media type. <ul style="list-style-type: none"> • Full-page label, Continuous paper, Transparent full-page label • Die-cut label (Blackmark) • Continuous paper (Blackmark) • Die-cut label (Gap), Transparent die-cut label |

- 7 The confirmation window appears. Click (Yes) to send the settings to the printer.
- 8 The following window appears. Click (OK).

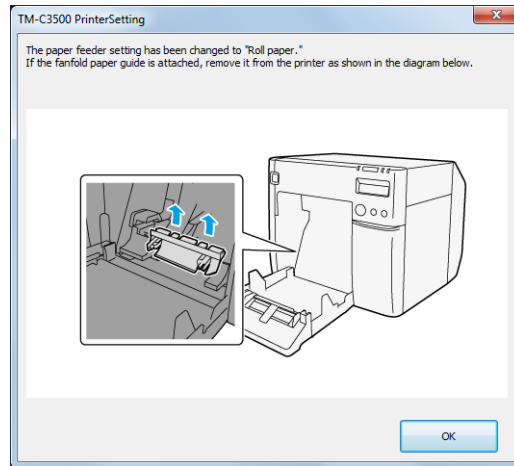

- 9 The completion window appears. Click (OK).

- 10** On the printer driver window, select (General) tab. Specify the media settings and click (OK).

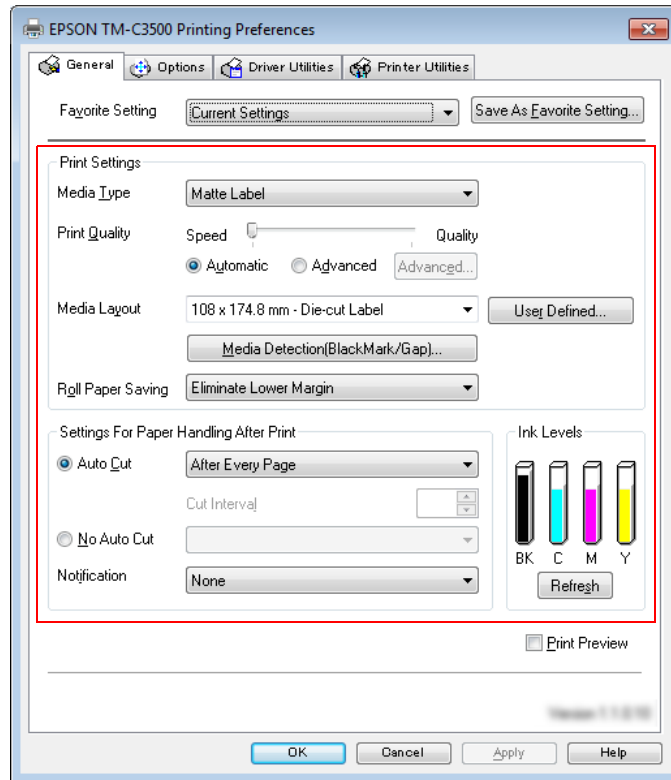

| Item | | Description |
|---|---------------|--|
| Print Settings | Media Type | Select the media type. |
| | Print Quality | Select the print quality. |
| | Media Layout | Select the media layout. If the media layout to be used is not included in the list, create a new layout. See the " Registering the Media Layout " on page 45. |
| Settings For Paper Handling After Print | Auto Cut | Select this to enable autotcut after printing. |
| | No Auto Cut | Select this to disable autotcut after printing. |

- 11** Turn the printer OFF.

CAUTION

Changes in the Media detection settings are saved in the memory in the printer when the printer is turned off.

- 12** Press down the release lever, and pull it to the front to open the roll paper cover.

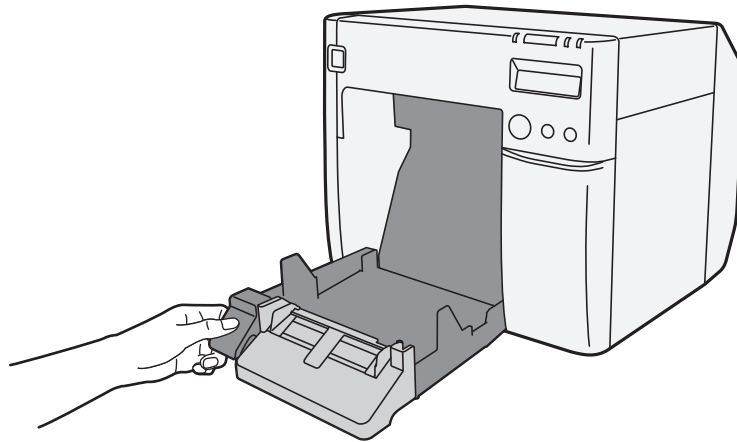

- 13** Remove the paper feed guide for fanfold paper.

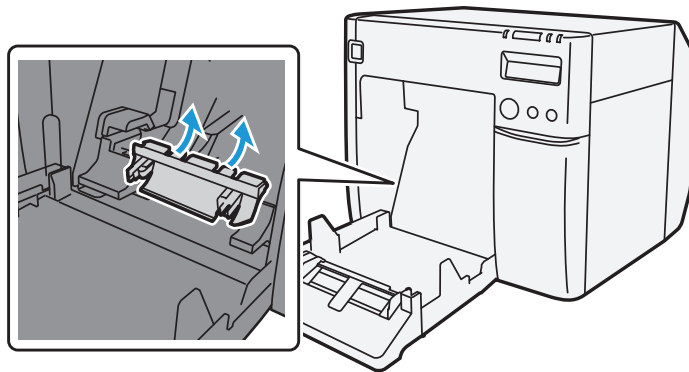

- 14** Unlock the roll paper guide.

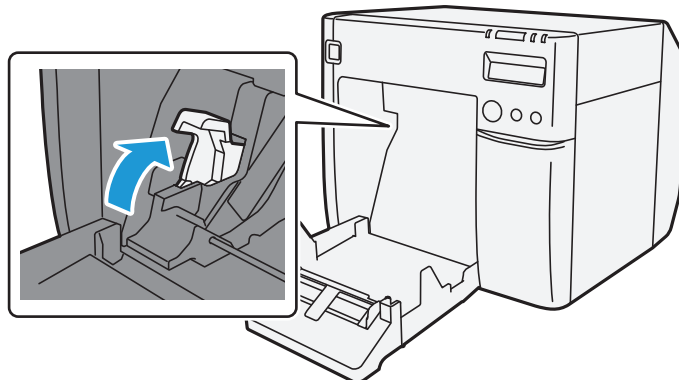

- 15** Move the left paper guide toward the direction of the arrow in the illustration below, and insert the roll paper all the way in with the print surface facing upward.

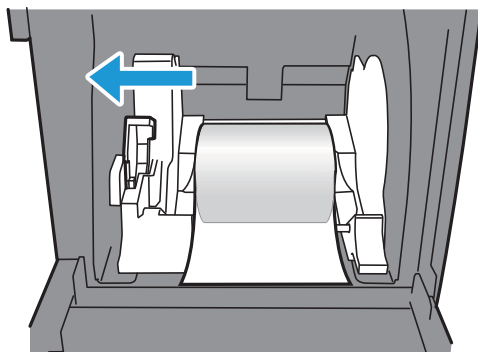

- 16** Lock the roll paper guide.

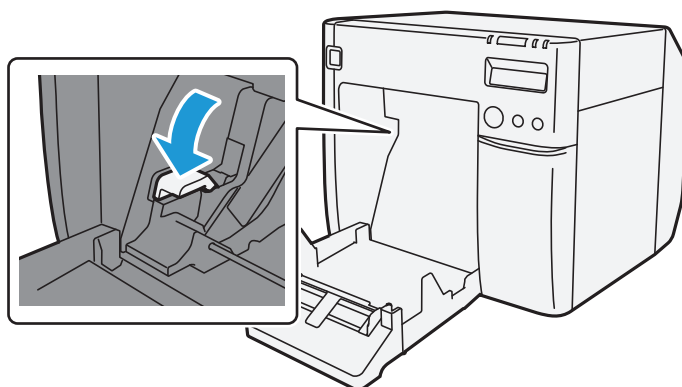

- 17** Refer to the shutter adjustment method label on the top of the printer, and open or close the shutters on the platen to match the width of the roll paper. If the shutter is set incorrectly, paper may be jammed or get dirty.

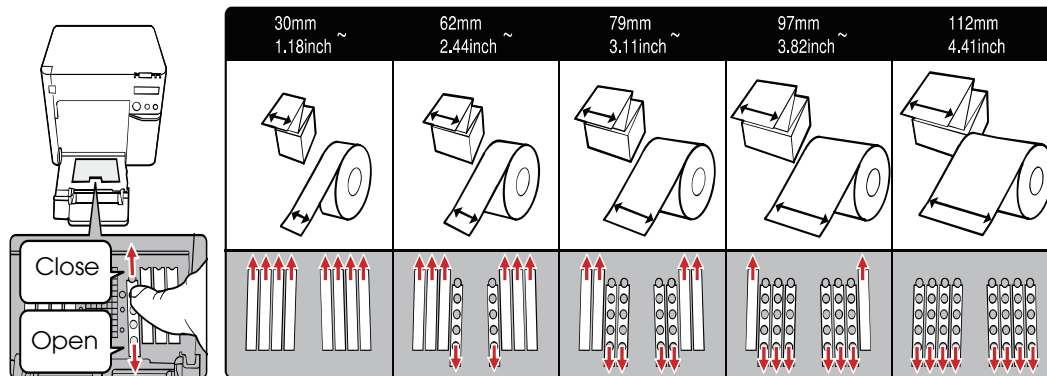

| Paper/backing width (mm) | Shutter open/close status |
|---|---|
| 30 mm {1.18"} or more, less than 62 mm {2.44"} | Close all shutters. |
| 62 mm {2.44"} or more, less than 79 mm {3.11"} | Open only the most inward shutters. |
| 79 mm {3.11"} or more, less than 97 mm {3.82"} | Open only the 2 most inward shutter rows. |
| 97 mm {3.82"} or more, less than 112 mm {4.41"} | Open only the 3 most inward shutter rows. |
| 112 mm {4.41"} | Open all shutters. |

- 18** Release the lock of the paper ejection guide with a fine-tipped tool.

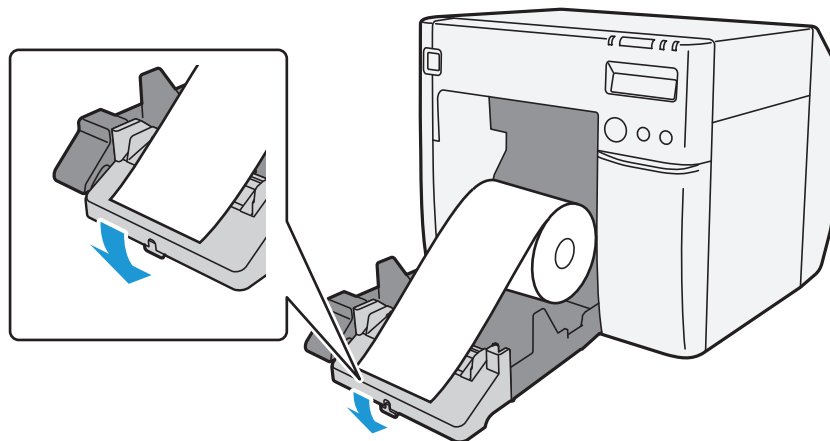

19 Adjust the paper ejection guide to the roll paper width.

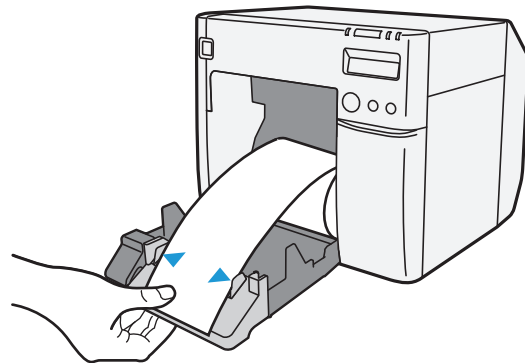

20 Lock the paper ejection guide and close the roll paper cover.

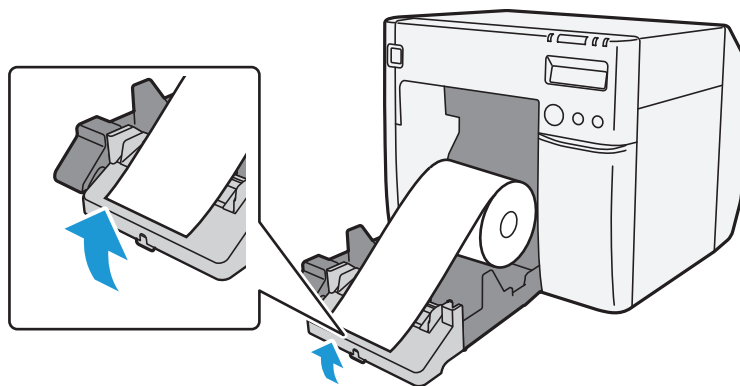

21 Turn the printer ON. After this, the printer feeds the paper automatically to remove any slack in the roll paper.

22 Confirm that the LCD displays an "R".

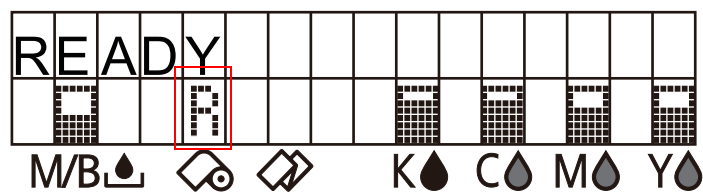

This is the end of loading of the roll paper.

Setting the Printer Driver

Favorite Setting

[Favorite Setting] is the function to administer print setting of the printer driver into one.

The setting from (General) and (Options) tab such as Media Type, Media Layout (including User Defined Media) are included.

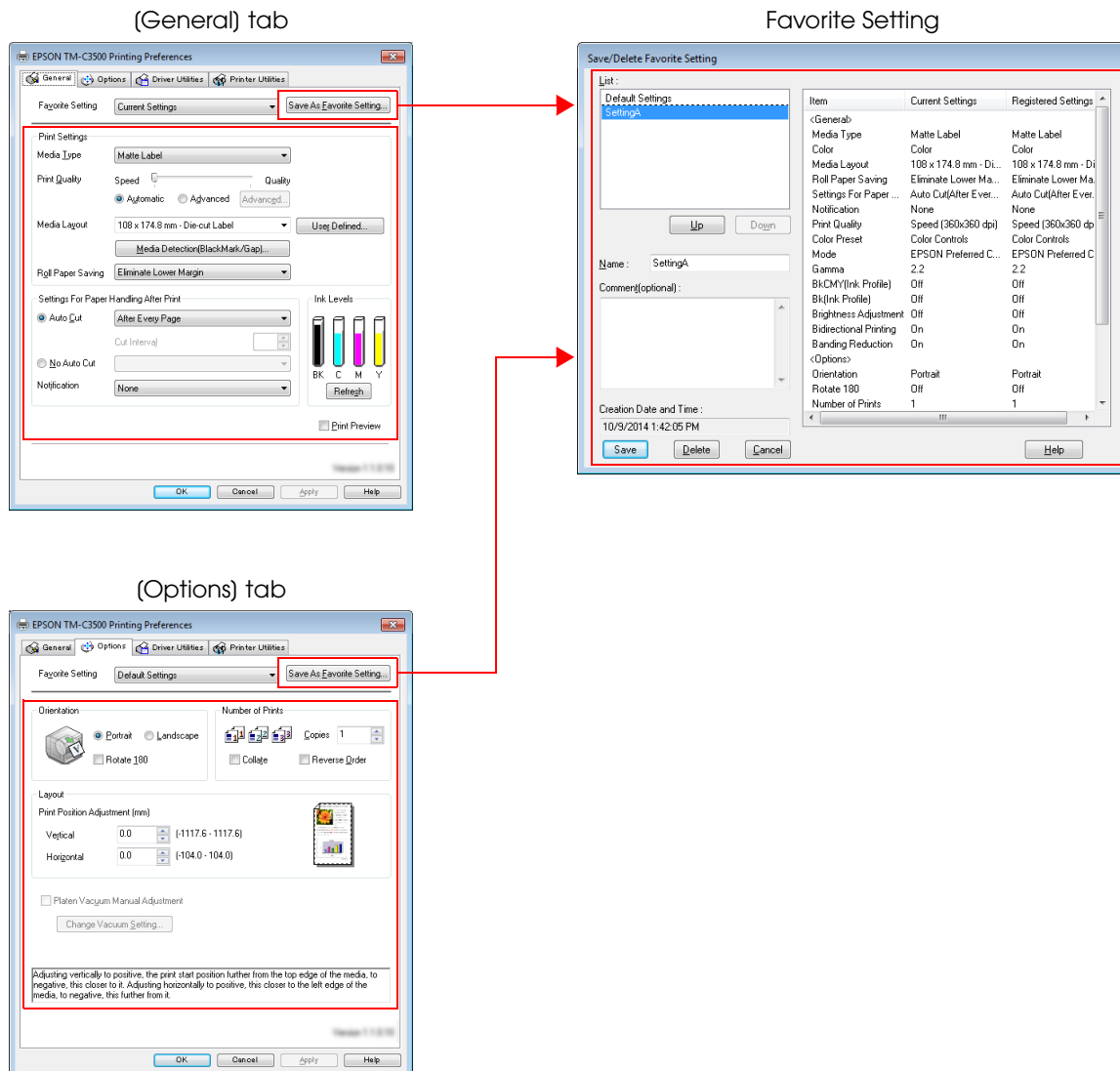

Features

- When printing from application, the print setting registered on [Favorite Setting] can be selected as default setting.
It is recommended to register the setting in favorite setting after executing print setting by clicking [Save As Favorite Setting].
- A number of setting can be registered on [Favorite Setting].
For example, if the print setting is registered on [Favorite Setting] for each document, the print setting can be completed by changing [Favorite Setting] when the document is changed. This prevents an error of setting change when changing the paper.
(It is necessary to change Media detection settings of the printer when the document is changed.)

Registering print setting on (Favorite Setting)

- 1 Set the printer driver depending on paper to print.
Set settings on (General) and (Options) tab. Select from Media Layout when using User Defined Media.
- 2 Click (Save As Favorite Setting) to display (Save/Delete Favorite Setting).
The current setting will be displayed on the list of the right side.
- 3 Enter print name.
- 4 Click (Add).
Print setting will be registered on (Favorite Setting).



[Favorite Setting] includes the following setting.

- **Default Settings:** The default setting when installing the printer driver.
- **Current Settings:** The contents set on (General) and (Options) tab.
These contents are displayed in the current settings on (Current Setting) and (Save/Delete Favorite Setting) window.
- **User Defined Setting:** The print setting defined by the user.

Information for User Definition

The user definition includes the following.

- User Defined Media
- Registering barcode font
- Replacing font on .NET environment

The user definition is set on each client computer. When a number of TM-C3500 printer drivers are installed in one computer, these are used mutually.

Exporting/Importing Printer Driver Settings

You can export the printing references, favorite setting, user-defined information (paper layout, barcode) and printer driver operation settings into a BSF file (extension of ".BSF"). You can also import the settings from a BSF file to set up the printer driver.

Export Settings

Follow the steps below to export the settings.

- 1 Select (Driver Utilities) tab. Click (Import/Export Settings).

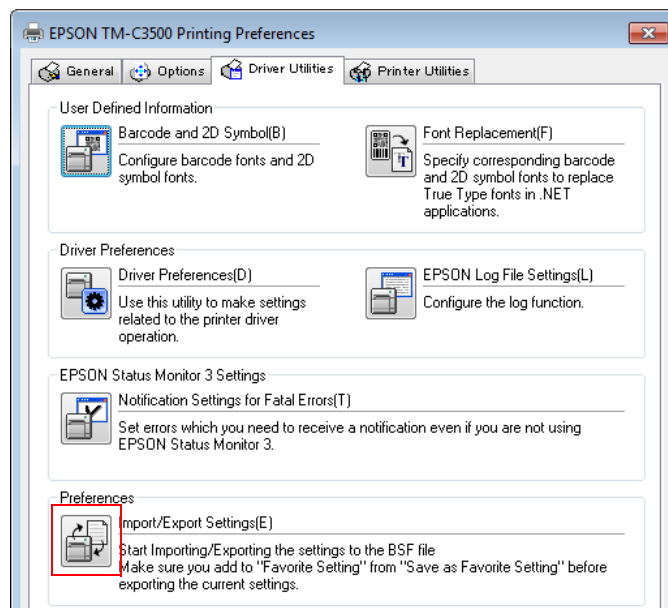

NOTE

- Export in a BSF file from the current setting. If you export it from the general setting, a different content will be exported.
Current setting:
Properties of the printer driver-[General]-[Printing References]-[Driver Utilities]-[Import/Export Settings]
General setting:
Properties of the printer driver-[Advanced]-[Printing Defaults]-[Driver Utilities]-[Import/Export Settings]
- Be sure to register the settings on the [General] tab to "favorite setting".
If not registered, the initial settings of the printer driver are applied.

-
- 2 "Import/Export Settings" window appears. Click (Export Settings).

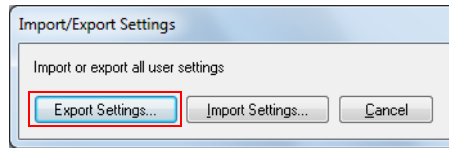

-
-
- 3 The window to save a file appears. Specify a name and save the BSF file.
- 4 The process completion window appears. Click (OK).

NOTE

To the BSF file, the print settings in "favorite setting" defined by the user are applied. The print settings in "Current settings" are not applied.

Import Settings

CAUTION

When the settings are imported from a BSF file, the printer driver settings are overwritten. Therefore, to retain the existing settings for the items listed below, create a BSF including the existing settings.

- * Favorite List
- * User Defined Media List
- * Barcode Font List
- * Barcode Font Replacement List

Follow the steps below to import the settings.

- 1 Select (Driver Utilities) tab. Click (Import/Export Settings).
- 2 "Import/Export Settings" window appears. Click (Import Settings).
- 3 The confirmation window appears. Click (OK).
- 4 The window to open a file appears. Select the file to be imported.
- 5 The process completion window appears. Click (OK).

Barcode Printing

The printer driver has the built-in barcode font. Barcode printing is available if the barcode is not created on the application side.

Setting the barcode font

Barcode print settings can be changed on **[Barcode and 2D Symbol]** on **[Driver Utilities]** tab.

Barcode and 2D Symbol Settings

Display : All Font Name :
 Font List : Type : UPC-A
 Specified Point : 57.5 Points
 Test Print
 012345678905
 Size Display(U) Print

Common Settings
 Rotation Settings : Normal Composite
 Hexadecimal Entry Mode Use a Quiet Zone

Barcode
 Module : 3 [3-9 dots] HRI Character Position : Do Not Print
 Bar Height : 288 [9-999 dots] HRI Font :
 Adjust Bar Width Element Ratio :
 Auto Convert to Minimize Entire Symbol Width Character Spacing :
 Width

Recommended Value
 Configure the barcode.
 The module size may differ from the specified size due to printer resolution which is determined by "Media Type" and "Print Quality". Click [Size Display] button and check the actual size.

Add Delete OK Cancel(Z) Help

1 Change settings of the following.

- **Display:** Select [**Barcodes**].
- **Font Name:** Input an arbitrary character string. ASCII characters only.
- **Type:** Select a barcode type from the following. The displayed items are changed accordingly.

| | | |
|--------------------------|--------------------------|--------------------------------|
| UPC-A | UPC-E | JAN13(EAN) |
| JAN8(EAN) | CODE39 | ITF |
| Codabar | CODE93 | CODE128 |
| GS1-128M | GS1-128 | GS1 DataBar Omnidirectional |
| GS1 DataBar Truncated | GS1 DataBar ExpandedM | GS1 DataBar Expanded |
| GS1 DataBar Limited | | |

- **Rotation Settings:** Select a setting when printing the barcode rotated by the specified rate.
- **Hexadecimal Entry Mode:** Turn on the check box when the data for barcode is specified on Hexadecimal Entry Mode.
- **Composite:** Turn on the check box to print barcode with a composite symbol.

NOTE

Separate the data specified to a composite symbol and a barcode with “\|” or “|\
Example: 1234567890\|012345678905

- **Use a Quiet Zone:** Leaves a blank margin around barcodes.

NOTE

The barcode printing position is moved based on the amount of margin.

- **Module:** Sets the thin element width in dots.

| Category | Graphic resolutions (Horizontal x vertical) (dpi) | Print direction *1 | Adjust Bar Width *2 | Upper Line: Minimum Module (by 360 dpi) Lower Line: Minimum Element Ratio | | |
|--|--|--------------------|---------------------|--|------------------------|------------------------|
| | | | | ANSI Grade D or higher | ANSI Grade C or higher | ANSI Grade B or higher |
| Plain, Plain label | 360 x 360 | Fence | Required | 4 dot 2.5 | - | - |
| | | Ladder | | 6 dot 2.5 | - | - |
| Synthetic label Matte Matte label Glossy label Wristband | 360 x 360 | Fence | | 3 dot 2.5 | 4 dot 2.5 | |
| | | Ladder | | 6 dot 2.5 (*3) | - (*3) | - |
| | 720 x 360 | Fence | | 3 dot 2.5 | 4 dot 2.5 | |
| | | Ladder | | 6 dot 2.5 (*3) | - (*3) | - |

- : Not supported

- *1: In some cases, dot missing and irregularity in ink shots may occur when printing ladder barcodes (when the barcodes from the start to stop are printed in a vertical direction), lowering the ANSI grade to F and making barcodes unrecognizable. Therefore, fence barcodes (when the barcodes from the start to stop are printed in a horizontal direction) are recommended to use. To use ladder barcodes, make consideration such as printing HRI characters.
- *2: Ink may penetrate the paper due to its characteristics, and bars of printed barcodes tend to become thicker. This tendency is more prominent with some papers. To maintain the barcode recognition rate, use methods such as reducing the data in a bar by 1 pixel and increasing the blank space by 1 pixel (Bar width adjustment). However, do not apply this method to two-dimensional symbols.

*3: By the combination of the specific paper type and the Symbol, the following conditions are available.

Wristband & CODE128 : Element = 5 dots (D-grade)

Wristband & Codabar : Element = 5 dots,
Element ratio = 2.5 (C-grade)

- Bar Height: Sets the element height with dots. Specified dots indicate the actual print size.
- Adjust Bar Width: Narrows the element width when printing. Make sure to select it only when the barcode is not clear enough to be read.
- HRI Character Position: Select the position of the HRI characters. Select [**Do Not Print**] when not printing.

NOTE

The printing position is limited for some types.

- HRI Font: Select the HRI character font size.
- Element Ratio: Sets the thick element width by the ratio to the thin element width.
- Character Spacing: Sets the character spacing (interval) by the ratio to the thin element width.
- Auto Convert to Minimize Entire Symbol Width:
Selectable when CODE128 is specified. This function minimizes the number of symbol characters required to express the given data string.

2 Click (**Add**).

The selected barcode font is saved and the font name is added to the font list.

NOTE

- The barcode font can be registered up to 30.
- The barcode font setting can be overwritten by clicking [Save] after selecting the font name from the font list and changing the setting.
- The barcode font setting can be deleted by clicking [Delete] after selecting the font name from the font list.
- Test print is executed according to the setting by clicking [Print] after inputting the text in the box.

Specifying the barcode data

Specify the barcode data by referring to the following descriptions.

About the composite symbol:

The composite component type is selected automatically depending on the digit number of the data. (CC-C is selected only when GS1-128 is set.)

| Composite Component Type | Encodable Digit Number |
|--------------------------|------------------------|
| CC-A | 1 ~ 56 digits |
| CC-B | 1 ~ 338 digits |
| CC-C | 1 ~ 2361 digits |

About the HRI character:

When the total width of the HRI character is larger than that of the barcode, the HRI character width is set as the barcode width.

UPC-A

Normal

- Specify the data of 11 to 12 digits.
- The first digit is an unchecked number system character.
- For data of 11 digits, a check digit is automatically added.
- For data of 12 digits, the 12th digit is regarded as a check digit, but not proved.

Composite (difference from Normal)

- For data of 12 digits, the 12th digit is ignored, and a check digit is automatically added.

UPC-E

Normal

- Specify the data of 11 to 12 digits.
- For data of 6 digits, the specified data is not changed, and a check digit is automatically added.
- For data of 7 digits, the 2nd to 7th digits become the data characters, and a check digit is automatically added.
- For data of 8 digits, the 2nd to 7th digits become the data characters, and the 8th digit is regarded as a check digit, but not proved.
- For data of 11 digits, a check digit is automatically added.
- For data of 12 digits, the 12th digit is regarded as a check digit, but not proved.
- For data of 7 digits or more, specify "0" for the first digit, since it is regarded as a number system character.

Composite (differences from Normal)

- For data of 8 digits, the 8th digit is ignored, and a check digit is automatically added.
- For data of 12 digits, the 12th digit is ignored, and a check digit is automatically added.

JAN13(EAN)

Normal

- Specify the data of 11 to 12 digits.
- For data of 12 digits, a check digit is automatically added.
- For data of 13 digits, the 13th digit is regarded as a check digit, but not proved.

Composite (difference from Normal)

- For data of 8 digits, the 8th digit is ignored, and a check digit is automatically added.

JAN8(EAN)

Normal

- Specify the data of 7 to 8 digits.
- For data of 7 digits, a check digit is automatically added.
- For data of 8 digits, the 8th digit is regarded as a check digit, but not proved.

Composite (difference from Normal)

- For data of 8 digits, the 8th digit is ignored, and a check digit is automatically added.

CODE39

A maximum of 256 digits can be specified.

When both or either one of start/stop code (“*”) is not specified, it is automatically added.

ITF

A maximum of 256 digits can be specified.

When data of odd digit number is specified, “0” is automatically added to the head.

Codabar

A maximum of 256 digits can be specified.

When the start code is not specified, ‘A’ is automatically added as a start code.

When the stop code is not specified, the same value as a start code is added as a stop code.

When the start/stop code is input in lower case letters, they are automatically converted into upper case letters.

CODE93

- Specify the data of 1 to 255 digits.
- A start code, 2 check digits, stop code is automatically added.
- A character (□) that indicates a start code is printed for the head of the HRI character.
- A character (□) that indicates a stop code is printed for the end of the HRI character.
- HRI characters of the control characters (00h ~1Fh, 7Fh) are printed combining '■' and an alphabetical character.

| Control Character | | HRI Character | Control Character | | HRI Character | Control Character | | HRI Character |
|-------------------|--------------|---------------|-------------------|--------------|---------------|-------------------|--------------|---------------|
| ASCII | Hexa-decimal | | ASCII | Hexa-decimal | | ASCII | Hexa-decimal | |
| NULL | 00 | ■U | VT | 0B | ■K | SYN | 16 | ■V |
| COH | 01 | ■A | FF | 0C | ■L | ETB | 17 | ■W |
| STX | 02 | ■B | CR | 0D | ■M | CAN | 18 | ■X |
| ETX | 03 | ■C | SO | 0E | ■N | EM | 19 | ■Y |
| EOT | 04 | ■D | SI | 0F | ■O | SUB | 1A | ■Z |
| ENQ | 05 | ■E | DLE | 10 | ■P | ESC | 1B | ■A |
| ACK | 06 | ■F | DC1 | 11 | ■Q | FS | 1C | ■B |
| BEL | 07 | ■G | DC2 | 12 | ■R | GS | 1D | ■C |
| BS | 08 | ■H | DC3 | 13 | ■S | RS | 1E | ■D |
| HT | 09 | ■I | DC4 | 14 | ■T | US | 1F | ■E |
| LF | 0A | ■J | NAK | 15 | ■U | DEL | 7F | ■F |

CODE128

- Specify the data of 2 to 255 digits.
- Specify either one of the code selection characters (CODE A, CODE B, CODE C) as a start code of the first 2 digits.
- A special character is indicated by combining '{' and the next character.
- When [Auto Convert to Minimize Entire Symbol Width] is checked, conversion is automatically performed so as to minimize the entire CODE128 symbol width. With this function, there is no need to specify a code set; barcode printing can be performed simply by inputting data you want to convert into symbols.

When [Auto Convert to Minimize Entire Symbol Width] is unchecked, a code set must be manually specified. When code set C is specified, assume a generated two-digit number as an ASCII character decimal number and specify the corresponding ASCII character.

Example: 37": Specify as "%".

"65": Specify as "A".

"979899": Specify as "abc".

- When the character right after '{' is not any of the following, an error occurs.

| Control Character | ASCII | Control Character | ASCII | Control Character | ASCII |
|-------------------|-------|-------------------|-------|-------------------|-------|
| SHIFT | {S | CODE C | {C | FNC3 | {3 |
| CODE A | {A | FNC1 | {1 | FNC4 | {4 |
| CODE B | {B | FNC2 | {2 | '{' | {{ |

- The HRI characters of the special character are described as below.

| Control Character | HRI Character |
|-----------------------------------|------------------|
| SHIFT | Not printed |
| CODE A/B/C | Not printed |
| FNC1~ 4 | Space is printed |
| Control character (00h ~1Fh, 7Fh) | Space is printed |

GS1-128

- ❑ Specify the data of 2 to 255 digits.
- ❑ '(' is the delimiter for the application identifiers. (printed as the HRI character, but not encoded.)
- ❑ The start codes (CODE A, CODE B, CODE C) and the stop code are added automatically.
- ❑ A symbol character FNC1, that is described after the start code, is automatically added.
- ❑ When '*' is specified, a check digit is automatically calculated, and replaced with '*'.
- ❑ 2 digits of consecutive numbers must be specified as the application identifier. If it is not specified correctly, an error occurs.
- ❑ When '(01)' is specified as the application identifier, the 14th digit becomes a check digit, however, it is not proved when the check digit is specified. When the 14th digit is '*', the check digit is automatically calculated, and replaced with '*'.
- ❑ A special character is indicated by combining '{' and the next character.
- ❑ When the character right after '{' is not any of the following, an error occurs.

| Control Character | ASCII | HRI Character |
|--|-------|-------------------------|
| Control Character (00h ~ 1Fh, 7Fh) | | Space is printed. |
| FNC1 | {1 | Space is printed. |
| FNC3 | {3 | Space is printed. |
| '{' | {{ | '{' is printed. |
| '(' | {{ | '(' is printed. |
| ')' | {} | ')' is printed. |
| '*' | {* | '*' is printed. |
| Left parenthesis for the application identifier | (| '(' is printed. |
| Right parenthesis for the application identifier |) | ')' is printed. |
| Check digit position | * | Check digit is printed. |

GS1-128M

- ❑ Specify the data of 38 to 66 digits.
- ❑ '(' is the delimiter for the application identifiers. (printed as the HRI character, but not encoded.)
- ❑ The start codes (CODE A, CODE B, CODE C) and the stop code are added automatically.
- ❑ A symbol character FNC1, which is described after the start code, is automatically added.
- ❑ When FNC1 is not at the end of the data followed by the application identifier '(30)', FNC1 is automatically added.
- ❑ FNC1 must not be at the end of the data followed by the application identifier '(10)' or '(21)'. In this case, an error occurs.
- ❑ When '(01)' is specified as the application identifier, the 14th digit becomes a check digit, however, it is not proved when the check digit is specified. When the 14th digit is '*', the check digit is automatically calculated, and replaced with '*'.
- ❑ When the character right after '{' is not '1', an error occurs.
- ❑ Specify the special character as the following format.

| Control Character | ASCII | HRI Character |
|--|-------|-------------------------|
| FNC1 | {1 | Space is printed. |
| Left parenthesis for the application identifier | (| (' is printed. |
| Right parenthesis for the application identifier |) |)' is printed. |
| Check digit position | * | Check digit is printed. |

- ❑ An error occurs when the format identifiers do not meet the following condition.

| Format Identifier | Format |
|-------------------|--------------------------------|
| 01 | Numbers of 14 digits |
| 10 | Alphanumerics of 1 ~ 20 digits |
| 17 | Numbers of 6 digits (YYMMDD) |
| 21 | Alphanumerics of 1 ~ 20 digits |
| 30 | Numbers of 1 ~ 8 digits |

GS1 DataBar Omnidirectional/GS1 DataBar Truncated/GS1 DataBar Limited

- ❑ The first application identifier '01' is not included in the data.
- ❑ When printing the HRI characters, the first application identifier '01' is printed as '(01)' before the packing identification code.
- ❑ A check digit need not to be attached to the barcode data.
- ❑ When printing the HRI character, a check digit is printed after a product code.
- ❑ For GS1 Databar Limited, specify '0' or '1' for the first digit.

GS1 DataBar ExpandedM

- ❑ Specify the data of 38 to 66 digits that does not include '*'.
- ❑ '(' is the delimiter for the application identifiers. (printed as the HRI character, but not encoded.)
- ❑ When FNC1 is not at the end of the data followed by the application identifier '(10)' or '(21)', FNC1 is automatically added.
- ❑ When FNC1 is not at the end of the data followed by the application identifier '(30)', FNC1 is automatically added.
- ❑ FNC1 must not be at the end of the data followed by the application identifier '(10)' or '(21)'. In this case, an error occurs.
- ❑ When '(01)' is specified as the application identifier, the 14th digit becomes a check digit. When the check digit is not correct, an error occurs.
(Unlike GS1-128, the check digit is not automatically calculated, nor replaced with '*'.)
- ❑ '*' is skipped.
- ❑ When the character right after '{' is not '1', an error occurs.
- ❑ Specify the special character using the following format.

| Control Character | ASCII | HRI Character |
|--|-------|-------------------|
| FNC1 | {1 | Space is printed. |
| `(` | {{ | '(' is printed. |
| `)` | }} | ') is printed. |
| Left parenthesis for the application identifier | (| '(' is printed. |
| Right parenthesis for the application identifier |) | ') is printed. |
| `*` | {* | '*' is printed. |
| Skipped character | * | Not printed. |

GS1 DataBar Expanded

- ❑ Specify the data of 2 to 255 digits.
- ❑ '(' is the delimiter for the application identifiers. (printed as the HRI character, but not encoded.)
- ❑ Be sure to include all the application identifiers in the data.
- ❑ When the first data is '01' after deleting application identifiers, left and right parenthesis, and '*' from the specified data, the 14th digit from the next of '01' is checked as a check digit. When it is not correct, an error occurs.
- ❑ When the next data of '01' is fewer than 14 digits, a check digit is not checked.
(Unlike GS1-128, the check digit is not automatically calculated, nor replaced with '*.' When '*' is specified, '*' is ignored, and the rest of the data is shifted by 1 digit.)
- ❑ Specify the special character using the following format.

| Control Character | ASCII | HRI Character |
|--|-------|-------------------|
| FNC1 | {1 | Space is printed. |
| Left parenthesis for the application identifier | (| '(' is printed. |
| Right parenthesis for the application identifier |) | ')' is printed. |
| '*' | {* | Error |
| Skipped character | * | Not printed. |

Printing method

Specify the selected barcode font, specified point and language to the printing data, and then print it.

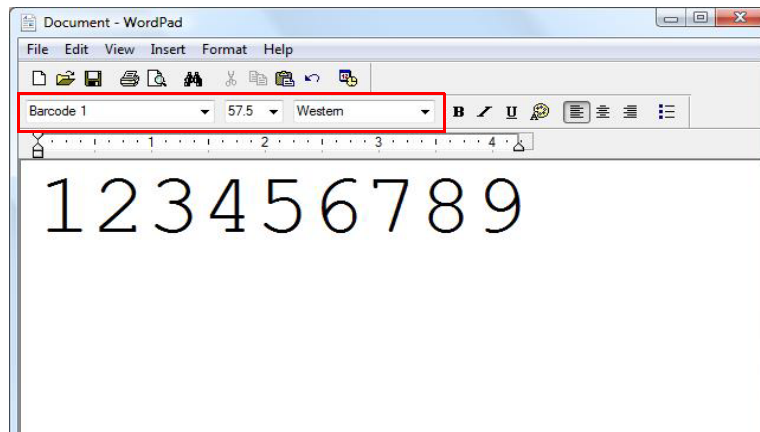

CAUTION

The font size of the barcode can not be changed by [Specified Point] value. The barcode is not printed when other values are selected.

2D Symbol Font Settings

The printer driver has the built-in 2D symbol font. 2D symbol printing is available if the 2D symbol is not created on the application side.

Setting the 2D Symbol font

2D symbol printing settings can be changed on **[Barcode and 2D Symbol]** on **[Driver Utilities]** tab.

Barcode and 2D Symbol Settings

Display : 2D Symbols Font Name :

Font List : Type : PDF417

Specified Point : 9.0 Points

Test Print
1234567890
Size Display(J) Print

Common Settings

Rotation Settings : Normal Composite
 Hexadecimal Entry Mode Use a Quiet Zone

PDF417

Module Width 3 [3-15 dots] Column 0 [0-30]
Module Height 3 [2-8] Step 0 [0,3-90]

Truncation Symbol Error Correction Level : Level 0

Recommended Value
Configure PDF417.

The module size may differ from the specified size due to printer resolution which is determined by "Media Type" and "Print Quality". Click [Size Display] button and check the actual size.

Add Delete OK Cancel Help

1 Change settings of the following.

- **Display:** Select [2D Symbols].
- **Font Name:** Input an arbitrary character string. ASCII characters only.
- **Type:** Select a 2D symbol type. The displayed items are changed accordingly.
- **Rotation Settings:** Select a setting when printing the 2D symbol rotated by the specified rate.
- **Hexadecimal Entry Mode:** Turn on the check box when the data for 2D symbol is specified on Hexadecimal Entry Mode.
- **Composite:** Turn on the check box to print the 2D symbol with a composite symbol.

NOTE

Separate the data specified to a composite symbol and a 2D symbol with “\|” or “|\
the data in the order of the composite symbol and the 2D symbol.

Example: 1234567890\|012345678905

- **Use a Quiet Zone:** Leaves a blank margin around 2D symbols.

NOTE

The 2D symbol printing position is moved based on the amount of margin.

2 Make settings of the following items according to the selected **(Type)**.

- PDF417
 - *Module Width: Makes settings of the module width for PDF417.
 - *Module Height: Makes settings of the module height for PDF417 by the ratio to the module width.
 - *Column: Input the number of columns for PDF417.
 - *Step: Enter the number of steps for PDF417.
 - *Truncation Symbol: Turn on this check box when making a symbol without the stop code.
 - *Error Correction Level: Select an error correction level for PDF417. The data can be read even if the part of the symbol is broken, and restoration ratio becomes higher for bigger numbers.

- QRCode
 - *Model: Select a QRCode model.
 - *Module: Select the width of cell (module) for QRCode.
 - *Version: Specify the version for QRCode. The number of characters that can be converted into 2D symbols is different depending on the version of QRCode.
 - *Error Correction Level: Select an error correction level for QRCode. The data can be read if the part of the symbol is broken and restoration ratio becomes higher in the order of level L, M, Q, H.
 - *Characters: Enter the number of QRCode digits.

- MaxiCode
 - *Mode: Select a MaxiCode mode. Turn on the check box of **[Hexadecimal Entry Mode]** when selecting **[Mode 2]** or **[Mode 3]**.

- GS1 DataBar
 - *Module: Sets the module width for GS1 DataBar.
 - *Num Of Chars: Sets the maximum width for GS1 DataBar.

- AztecCode
 - *Type: Select a mode for AztecCode.
 - *Number of Layers: Select the number of layers for AztecCode.
[Minimize]: Optimize the minimum number of layers automatically.
[Specify the Size]: Change the number of layers specified by the value in the input box.
 - *Cell Size: Sets the cell (module) size for AztecCode.
 - *Error Correction Area: Specify the error correction area of AztecCode using of either the following. The data can be read even if the part of the symbol is broken, and restoration ratio becomes higher for bigger numbers.
[Default Value]: Default value is 23%+3 code words.
[Specify a Percentage]: Specify the error correction area with a percentage value in the input box.

- DataMatrix
 - *Cell Size: Makes settings of the cell (module) size for DataMatrix.
 - *Number of Cells: Makes settings of the number of cells for DataMatrix.
[Minimize]: Optimize the minimum number of cells automatically.
[Specify the Size]: Change settings to the selected size.

- DataMatrix(Rectangle)

- *Cell Size: Makes settings of the cell (module) size for DataMatrix.
 - *Number of Vertical Cells: Specify the number of cells for DataMatrix in the vertical direction.
 - *Number of Horizontal Cells: Specify the number of cells for DataMatrix in the horizontal direction.
- [**Minimize**]: Optimize the minimum number of cells automatically.
 [**Specify the Size**]: Change settings to the selected size.

□ The following table shows the recommended value for the 2D symbol module.

- Recommended value for setting the barcode/2D symbol font (2D symbol of stack type) (PDF417, GS1 DataBar Stacked, GS1 DataBar Stacked Omnidirectional, GS1 DataBar Expanded Stacked)

| Category | Graphic resolutions (Horizontal x vertical) (dpi) | Print Status (*1) | Adjust Bar Width (*2) | Minimum Module (by 360 dpi) | | |
|------------------------------------|---|-------------------|-----------------------|-----------------------------|------------------------|------------------------|
| | | | | ANSI Grade D or higher | ANSI Grade C or higher | ANSI Grade B or higher |
| Plain, Plain label | 360 x 360 | No Paper feed | 3 | 6 dot | - | - |
| | | With Paper feed | | 6 dot | - | - |
| Synthetic label Matte | 360 x 360 | No Paper feed | | 4 dot | - | - |
| | | With Paper feed | | 4 dot | -(*2) | - |
| Matte label Glossy label Wristband | 720 x 360 | No Paper feed | | 4 dot | - | - |
| | | With Paper feed | | 4 dot | -(*2) | - |

- : Not supported.

*1 : Whether paper feed is performed during printing 2D symbol can be checked in [**Display Media Feed Position**] - [**Display Print Preview**] in the Print Preview function. For this function, see "[Print Preview](#)" on page 110.

*2: Specify when using PDF417.

- Recommended value for setting the barcode/2D symbol font (2D symbol of matrix type) (AztecCode, QRCode)

| Category | Graphic resolutions (Horizontal x vertical) (dpi) | Print Status (*1) | Minimum Cell Size (by 360 dpi) | | |
|---|--|-------------------|-----------------------------------|------------------------------|------------------------------|
| | | | ANSI Grade D or higher | ANSI Grade C or higher | ANSI Grade B or higher |
| Plain, Plain label | 360 x 360 | No Paper feed | 6 dot | - | - |
| | | With Paper feed | 8 dot | - | - |
| Synthetic label Matte Matte label | 360 x 360 | No Paper feed | 5 dot | 6 dot (*2) | |
| | | With Paper feed | 6 dot | 7 dot | - |
| Glossy label Wristband | 720 x 360 | No Paper feed | 5 dot | 6 dot (*2) | |
| | | With Paper feed | 6 dot | 7 dot | - |

- : Not supported.

*1: Whether paper feed is performed during printing 2D symbol can be checked in [**Display Media Feed Position**] - [**Display Print Preview**] in the Print Preview function. For this function, see "[Print Preview](#)" on page 110.

*2: Only QRCode is confirmed.

3 Click (**Add**).

The selected 2D symbol font is saved and the font name is added to the font list.

NOTE

- The 2D symbol font can be registered up to 30.
- The 2D symbol font setting can be overwritten by clicking [Save] after selecting the font name from the font list and changing the setting.
- The 2D symbol font setting can be deleted by clicking [Delete] after selecting the font name from the font list.
- Test print is executed according to the setting by clicking [Print] after inputting the text in the box.

Specifying the 2D symbol data

See the following description to specify the 2D symbol data.



For the composite symbol and the HRI character, see ["Specifying the barcode data" on page 93](#).

PDF417

- Calculated automatically when the digit number and the line number are 0.
- To specify other number than 0, make sure the multiplication of the digit number and the line number is under 928.

QRCode

- Size is determined by the specified version. If it does not fit in the specified version, it is changed automatically to the appropriate version.

MaxiCode

- For Mode2 and Mode3, the header and the second message are omissible.
- Specify the special character as the following format.

| Control Character | Hexadecimal |
|-------------------|-------------|
| SHIFT | 0x7B, 0x53 |
| CODE B | 0x7B, 0x42 |
| CODE C | 0x7B, 0x43 |
| FNC1 | 0x7B, 0x31 |
| FNC2 | 0x7B, 0x32 |
| FNC3 | 0x7B, 0x33 |
| FNC4 | 0x7B, 0x34 |

GS1 DataBar Stacked /GS1 DataBar Stacked Omnidirectional

- Up to 13 digits of data can be specified.
- Do not specify the application identifier '01' for the head of the data.
- A check digit need not to be attached to the data.

GS1 DataBar Expanded Stacked

- Multiple line symbol version of GS1 Databar Expanded. How to specify the data is the same as GS1 Databar Expanded. (For details, see ["GS1 DataBar Expanded" on page 100](#).)

AztecCode

- ❑ Supports the full range mode and the compact mode.

DataMatrix

- ❑ Supports the ECC200 versions - square and rectangular.

Printing method

Specify the selected 2D symbol font, specified point and language to the printing data, and print it.

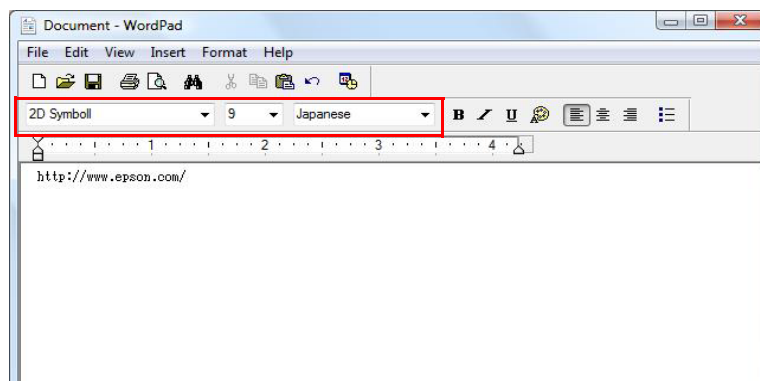
**CAUTION**

The font size of the 2D symbol can not be changed by [Specified Point] value.
The 2D symbol is not printed when other values are selected.

Barcode and 2D Symbol Font Printing on .NET Environment

Since .NET Framework supports only True Type font and Open Type font, the barcode and 2D symbol font which are registered in the printer driver can not be printed from the application. Therefore, True Type font is replaced with barcode and 2D symbol font by using font replacement function of the printer driver. Barcode and 2D symbol fonts can be printed from the application under .NET Framework environment by this replacement function.

The name of the print data in the application remains as True Type font name, but changes to barcode and 2D symbol font when it is printed.

Font Replacement

Font Replacement is executed from **(Font Replacement)** on **(Driver Utilities)** tab.

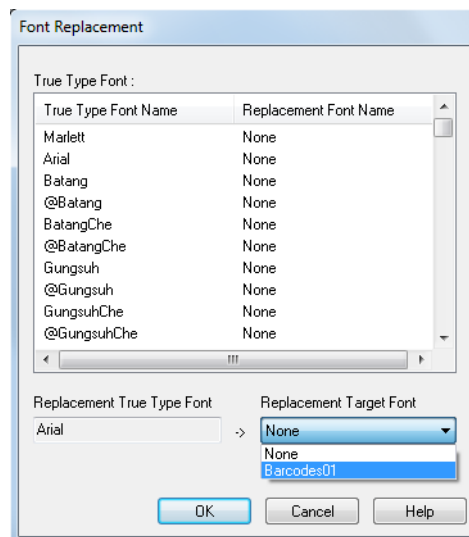

1 Make the following setting.

- True Type font to be replaced
 - * Select [True Type Font].
- Font to replace
 - * Select barcode and 2D symbol font to replace.

2 Click **(OK)**.

True Type font is replaced by barcode and 2D symbol font.

Printing barcode and 2D symbol

Sets specified number of point, language of the replaced True Type font by barcode and 2D symbol font to the print data.

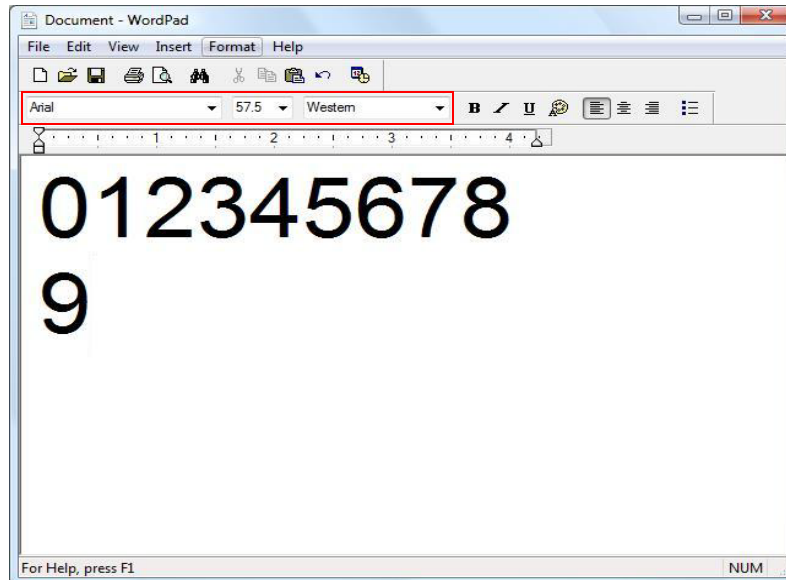

NOTE

- The number of point for barcode and 2D symbol is specified, check it from [Barcode and 2D Symbol] on [Driver Utilities]. The barcode and 2D symbol can not be printed if a value other than those specified is set.
- The replaced True Type font can be used only for specifying barcode and 2D symbol, therefore, if the character other than specified is used can not be printed. Make sure to use True Type font that is not be used for other printing.

Print Preview

If this function is checked, the print preview window is displayed when printing is performed from an application, allowing you to check the print result image before printing.

Displays the print preview before printing if this check box is turned on.

NOTE

To improve 2D symbol scanning accuracy, we recommend no paper feed during 2D symbol printing.

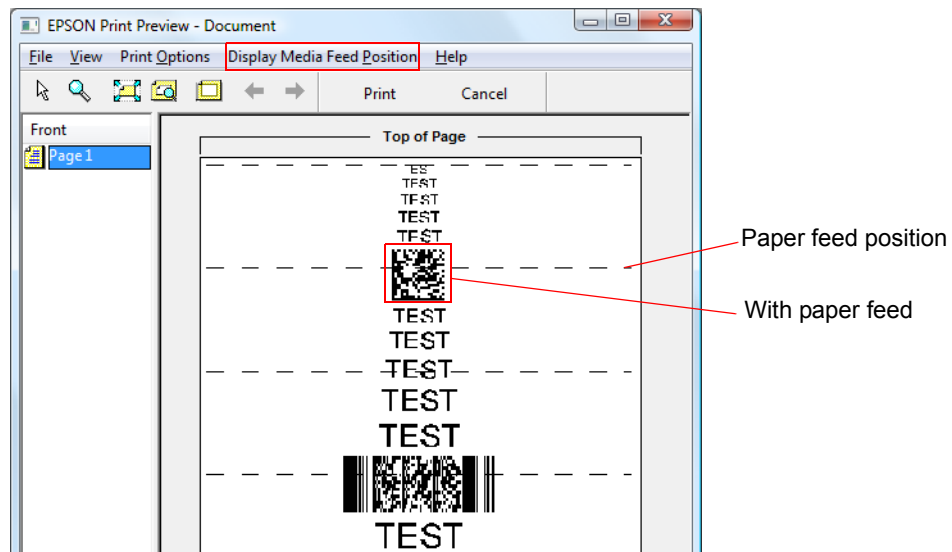

The following items can be set in [Display Media Feed Position].

| Setting | | Specification |
|-----------------------------|---------------------------|--|
| Display Media Feed Position | Display Print Preview | Displays the media feed position on the print preview window. The default is set as "Display". |
| | Print Media Feed Position | Prints the media feed position. The default setting is set as "Not print". |

Settings For Paper Handling After Print

Follow the steps below to set whether to enable autocut after printing and paper feed settings.

- 1 Display the printer driver window.
(See "How to Display the Printer Driver" on page 43.)
- 2 On (General) tab, set (Settings For Paper Handling After Print).

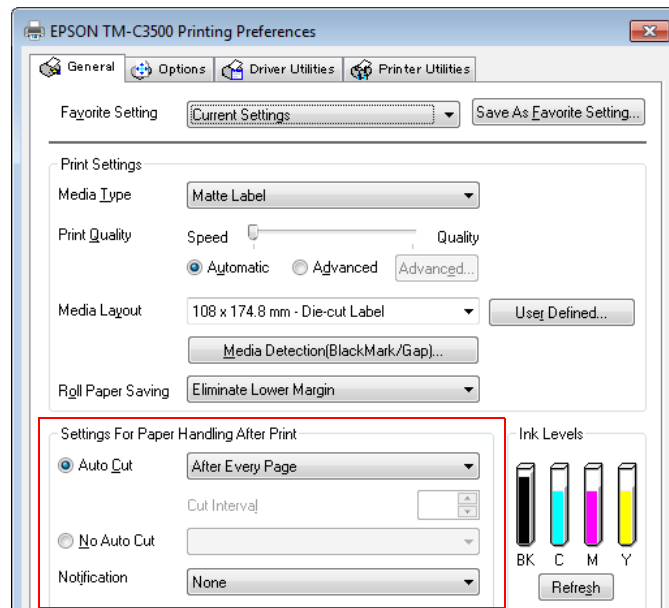

| Item | | Description |
|-------------|--------------------------------|--|
| Auto Cut | After Every Page | After printing, the paper is fed to the position where autcutting is possible and is automatically cut on a page-by-page basis. When resuming printing, the paper is fed in the reverse direction to the printing position and then printing resumes. |
| | Only After Last Page | After printing, the paper is fed to the position where autcutting is possible and only the last page is automatically cut. When resuming printing, the paper is fed in the reverse direction to the printing position and then printing resumes. |
| | After Specified Number Of Page | Specify the cut interval. After printing, the paper is fed to the position where autcutting is possible and is automatically cut at specified intervals. When resuming printing, the paper is fed in the reverse direction to the printing position and then printing resumes. |
| No Auto Cut | Feed To Peel Off Position | After printing, the paper is fed to the position where autcutting is possible, and stops without performing autcutting. Paper cutting is possible with the CUT button. When resuming printing, the paper is fed in the reverse direction to the printing position and then printing resumes. |
| | Feed To Cut Position | After printing, the paper is fed to the position where peeling is possible, and stops. Paper cutting is possible with the CUT button. When resuming printing, the paper is fed in the reverse direction to the printing position and then printing resumes. |

3 Click (OK).

The settings for paper handling after print are applied and saved.

Beeper

Follow the steps below to set whether to sound the beeper after printing and the timing to sound the beeper.

- 1 Display the printer driver window.
(See "How to Display the Printer Driver" on page 43.)
- 2 On (General) tab, select (Notification).

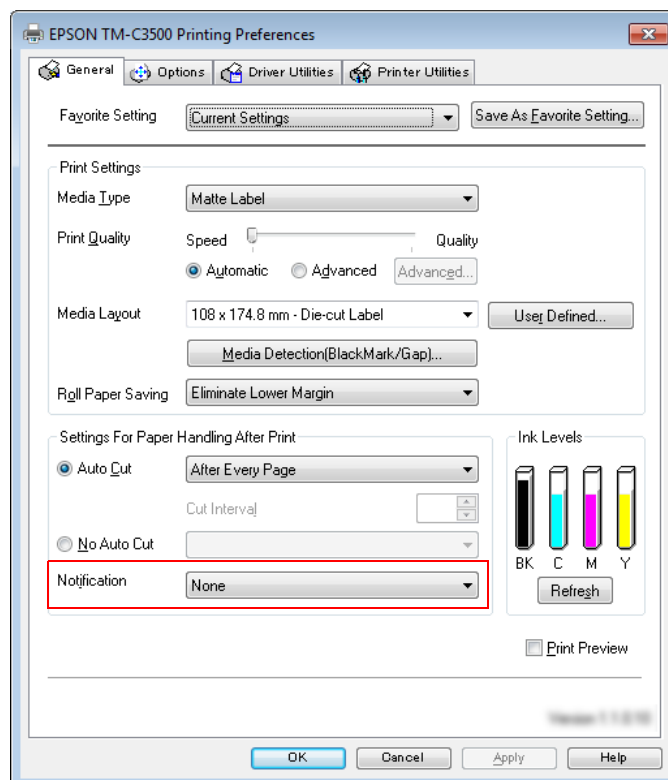

| Item | Description |
|------------------|---|
| None | The beeper is not used. |
| Beep at Page End | The beeper is set off after each page is printed. |
| Beep at Job End | The beeper is set off after the last page is printed. |

- 3 Click (OK).
The settings for beeper sound are applied and saved.

Setting the Printer

Media detection settings

This product can perform the following four types of [Media detection settings]. The aforementioned [Media source settings] and the [Media detection settings] are related as below table.

- Full-page label/Continuous paper/Transparent full-page label
Detects paper presence only and does not adjust the paper position.
- Die-cut label (Blackmark)
When adjusting the position of die-cut labels using the black mark, this adjusts the print position and autotcut position in relation to the black mark top position.
- Continuous paper (Blackmark)
When adjusting the position of continuous paper using the black mark, this adjusts the print position and autotcut position in relation to the black mark top position.
- Die-cut label (Gap)/Transparent die-cut label
When adjusting the position of die-cut label using the gap, this adjusts the print position and autotcut position in relation to the label top position.

| Media detection settings | Media source settings | |
|--|-----------------------|---------------|
| | Roll Paper | Fanfold Paper |
| Full-page label/Continuous paper/Transparent full-page Label | Available | Unavailable |
| Die-cut label (Blackmark) | Available | Available |
| Continuous paper (Blackmark) | Available | Available |
| Die-cut label (Gap)/Transparent die-cut label | Available | Available |

Setting procedure

Follow the steps below to set the Media detection settings.

- 1** Remove the paper.
 - For roll paper:
See step 1 in ["Replacing Roll Paper with Fanfold Paper" on page 66.](#)
 - For fanfold paper:
See steps 1 to 2 in ["Replacing Fanfold Paper with Roll Paper" on page 75.](#)
- 2** Turn the printer ON.
- 3** Display the printer driver window.
(See ["How to Display the Printer Driver" on page 43.](#))
- 4** Select the (Printer Utilities) tab, and then click (Printer References) in (Printer Setting Utility).
- 5** The TM-C3500 PrinterSetting screen is displayed. Select (Basic Settings) - (Media Settings).

- 6 The "Media settings" screen is displayed. Set (Media detection settings). Click (Apply Settings).

When fanfold paper is selected, the gap may not be detected depending on the paper you are using. If this happens, perform [Adjust the Label Gap Detection Sensor]. For details, see "[Sensor Adjustment](#)" on page 135.

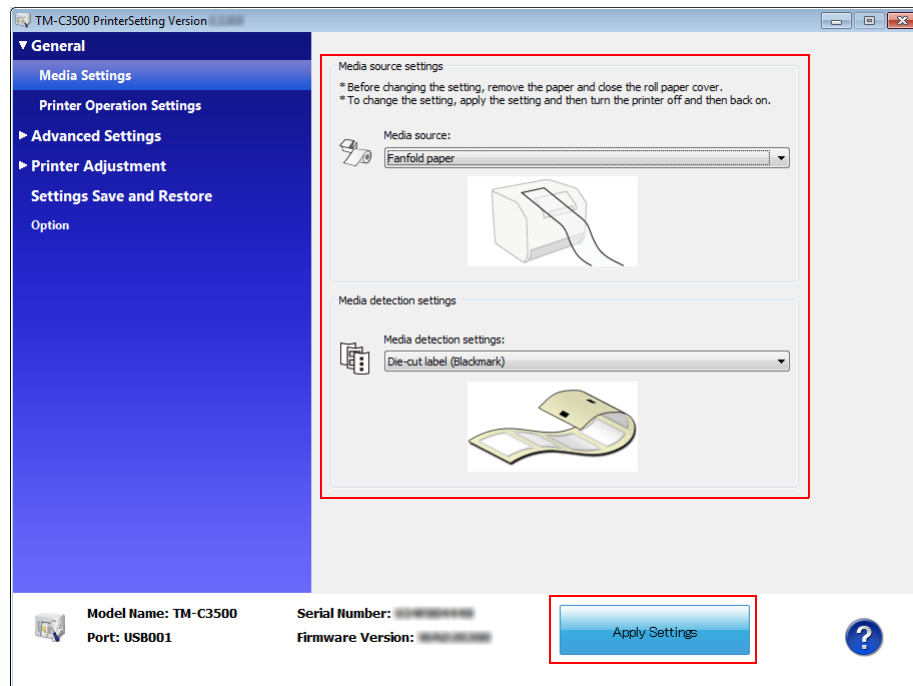

- 7 The confirmation window appears. Click (Yes) to send the settings to the printer.

- 8 Turn the printer OFF.

CAUTION

Changes in the Media detection settings are saved in the memory in the printer when the printer is turned off.

NOTE

The gap may not be detected depending on the paper you are using. If this happens, perform [Adjust the Label Gap Detection Sensor]. For details, see "[Sensor Adjustment](#)" on page 135.

Nozzle Check Mode Settings

The following modes are available for the printing operation mode setting. (The mode is set to [Anti-missing read mode] by default. If you use the default setting, there is no need to change the settings.)

- Anti-missing Dot Mode
- Anti-missing Read Mode
- Anti-missing Color Mode
- No Missing Dot Detection Mode

(For details on each mode, see "[Auto nozzle check system](#)" on page 24.)

How to Set the Mode

- 1** Turn the printer on.
- 2** Display the printer driver window.
(See "[How to Display the Printer Driver](#)" on page 43.)
- 3** Select (Printer Utilities) tab and click (Printer Setting Utility) under (Printer Preferences).
- 4** TM-C3500 PrinterSetting window appears. Select (General)-(Printer Operation Settings).

- 5 "Printer Operation Settings" window appears. Set (Nozzle Check Mode) under (Nozzle Check Mode Settings). Then, click (Apply Settings).

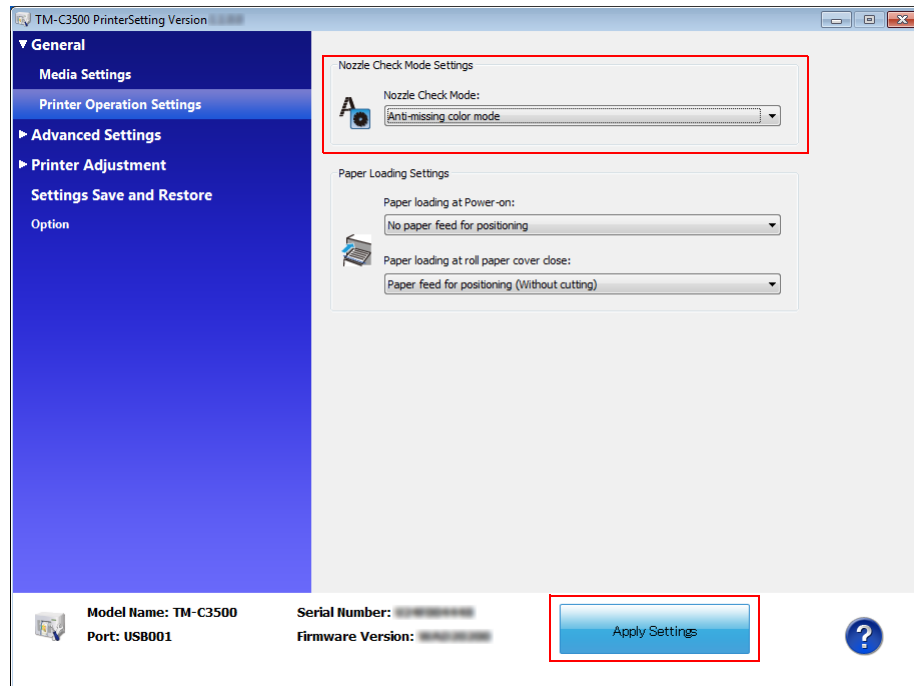

- 6 The confirmation window appears. Click (Yes) to send the settings to the printer.

Paper Loading Settings

Follow the steps below to specify the settings for paper loading at power-on/paper cover close. The following types are available for the settings for paper loading at power-on/paper cover close. (The type is set to [Paper feed for positioning (With cutting)] by default. If you use the default setting, there is no need to change the settings.)

Paper loading at power-on

| Settings | Description |
|--|---|
| Paper feed for positioning (With cutting) | <p>Paper loading settings: Die-cut label (Blackmark), Continuous paper (Blackmark), Die-cut label (Gap)/Transparent die-cut label</p> <p>Paper is loaded based on the upper end of black mark/label detected by the black mark detector or label detector. After paper feed is finished, autocut is performed and the printer enters the standby status.</p> <p>Paper loading settings: Full-page label/Continuous paper/Transparent full-page label</p> <p>A certain amount of paper is fed. After paper feed is finished, autocut is performed and the printer enters the standby status.</p> |
| Paper feed for positioning (Without cutting) | <p>Paper loading settings: Die-cut label (Blackmark), Continuous paper (Blackmark), Die-cut label (Gap)/Transparent die-cut label</p> <p>Paper is loaded based on the upper end of black mark/label detected by the black mark detector or label detector. After paper feed is finished, no autocut is performed and the printer enters the standby status.</p> <p>Paper loading settings: Full-page label/Continuous paper/Transparent full-page label</p> <p>A certain amount of paper is fed. After paper feed is finished, no autocut is performed and the printer enters the standby status.</p> |
| No paper feed for positioning | No paper loading or paper feeding is performed. |

Paper feed for positioning (Without cutting)

| Settings | Description |
|---|---|
| <p>Paper feed for positioning (With cutting)</p> | <p>Paper loading settings: Die-cut label (Blackmark), Continuous paper (Blackmark), Die-cut label (Gap)/Transparent die-cut label</p> <p>Paper is loaded based on the upper end of black mark/label detected by the black mark detector or label detector. After paper feed is finished, autocut is performed and the printer enters the standby status.</p> <p>Paper loading settings: Full-page label/Continuous paper/Transparent full-page label</p> <p>A certain amount of paper is fed. After paper feed is finished, autocut is performed and the printer enters the standby status.</p> |
| <p>Paper feed for positioning (Without cutting)</p> | <p>Paper loading settings: Die-cut label (Blackmark), Continuous paper (Blackmark), Die-cut label (Gap)/Transparent die-cut label</p> <p>Paper is loaded based on the upper end of black mark/label detected by the black mark detector or label detector. After paper feed is finished, no autocut is performed and the printer enters the standby status.</p> <p>Paper loading settings: Full-page label/Continuous paper/Transparent full-page label</p> <p>A certain amount of paper is fed. After paper feed is finished, no autocut is performed and the printer enters the standby status.</p> |

- 1 Turn the printer on.
- 2 Display the printer driver window.
(See "How to Display the Printer Driver" on page 43.)
- 3 Select (Printer Utilities) tab and click (Printer Setting Utility) under (Printer Preferences).
- 4 TM-C3500 PrinterSetting window appears. Select (General)-(Printer Operation Settings).
- 5 "Printer Operation Settings" window appears. Specify each item for (Paper Loading at Power -on). Then, click (Apply Settings).

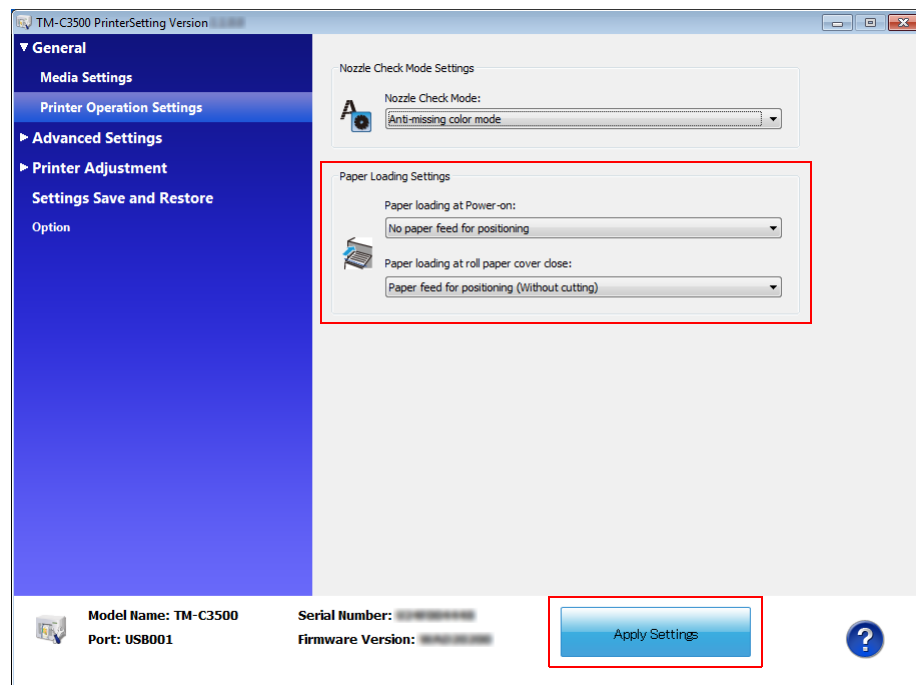

- 6 The confirmation window appears. Click (Yes) to send the settings to the printer.

Notification Settings

Sets following notification setting.

- **Beep Notification Setting at an Error**
Selects beep notification (sounds buzzer or not) when error occurs. (Default setting is (Beep). The user does not need to change when using with default setting.)
- **LED Notification Setting at Ink Low**
Selects LED notification (lights LED or not) when ink level is low. (Default setting is (LED On). The user does not need to change when using with default setting.)
- **Notification Setting at a Paper Size/Type Error**
Selects notification setting at a paper size or type error. Lights Error LED and Paper LED when detecting an error, and notifies error if EPSON Status Monitor 3 is in active. (Default setting is (No Error Notification). The user does not need to change when using with default setting.)

Follow the steps below to set the notification setting.

- 1** Turn the printer on.
- 2** Display the printer driver window.
(See "[How to Display the Printer Driver](#)" on page 43.)
- 3** Select (Printer Utilities) tab and click (Printer Setting Utility) under (Printer Preferences).
- 4** TM-C3500 PrinterSetting window appears. Select (Advanced Settings) - (Notification Settings).

- 5 "Notification Settings" window appears. Specify each item. Then, click (Apply Settings).

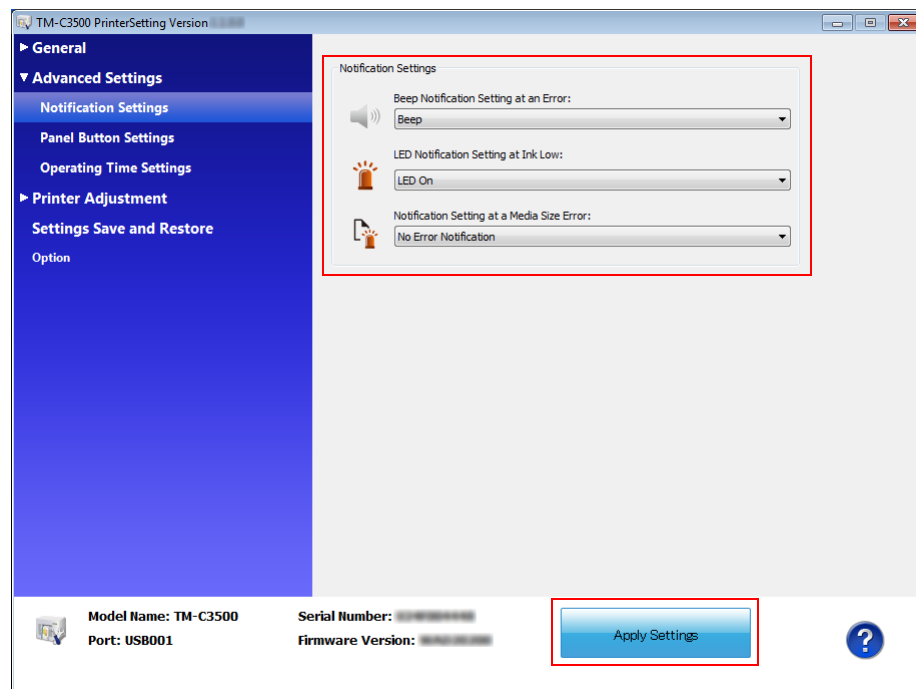

- 6 The confirmation window appears. Click (Yes) to send the settings to the printer.

Panel Button Settings

Enable/disable the panel buttons of this printer.

| Panel Button | Operation Caused by Panel Button | Settings |
|-----------------|----------------------------------|--|
| Feed Button | Paper feed | Enable / Disable |
| Cut Button | Paper cut | Enable / Disable |
| Cleaning Button | Head cleaning | Enable(Also Enabled During Printing)/ Enable(Disabled During Printing) / Disable |

Follow the steps below to make the setting.

- 1** Turn the printer on.
- 2** Display the printer driver window.
(See "[How to Display the Printer Driver](#)" on page 43.)
- 3** Select (Printer Utilities) tab and click (Printer Setting Utility) under (Printer Preferences).
- 4** TM-C3500 PrinterSetting window appears. Select (Advanced Settings) - (Panel Button Settings).

- 5 "Panel Button Setting" window appears. Specify each item. Then, click (Apply Settings).

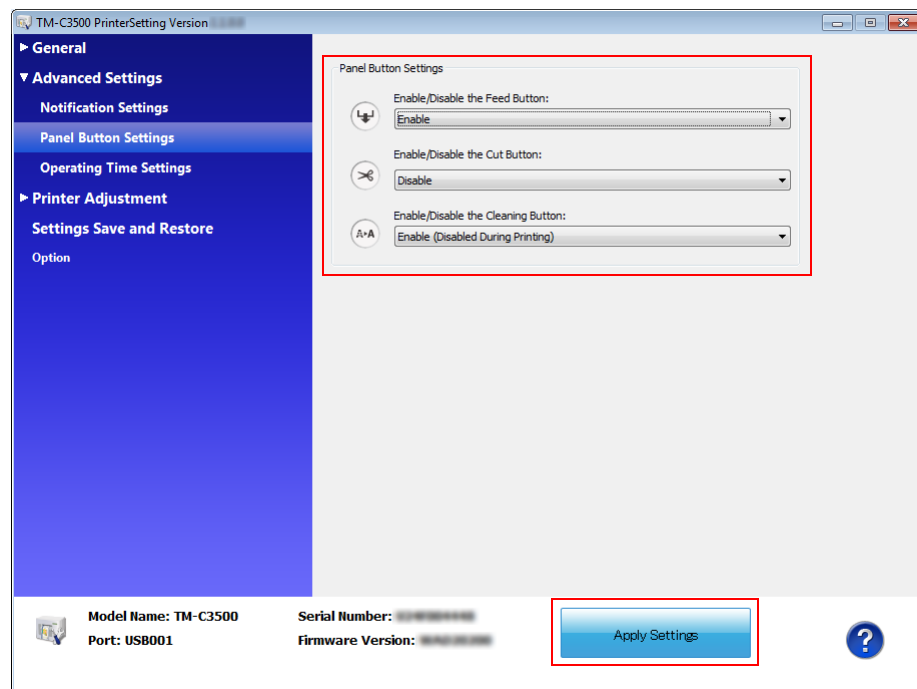

- 6 The confirmation window appears. Click (Yes) to send the settings to the printer.

Operating Time Settings

Allows you to specify the following:

| Settings | Description |
|---|---|
| Platen Vacuum Operation Pause Time Settings | Allows you to specify the time before stopping the platen vacuum fan after printing completion. The time may be extended up to 12 hours in accordance with the way the printer is used. Furthermore, the printer may also be set not to go into sleep state. |
| Data Standby Time Settings | Allows you to specify the time the printer will wait for the next data to arrive after printing completion. The time may be extended up to 15 seconds in accordance with the way the printer is used. |

NOTE

The printer stops the fan and goes into sleep state when printing completes. Then, when the next printing starts, the printer starts the fan and comes out of the sleep state. For this reason, work efficiency is low when the printer is used intermittently every few seconds. In such a case, work efficiency may be improved by increasing the time settings in accordance with the way the printer is used.

- 1 Turn the printer on.
- 2 Display the printer driver window.
(See "How to Display the Printer Driver" on page 43.)
- 3 Select (Printer Utilities) tab and click (Printer Setting Utility) under (Printer Preferences).
- 4 TM-C3500 PrinterSetting window appears. Select (Advanced Settings)-(Operating Time Settings).
- 5 "Operating Time Settings" window appears. Specify each item. Then, click (Apply Settings).

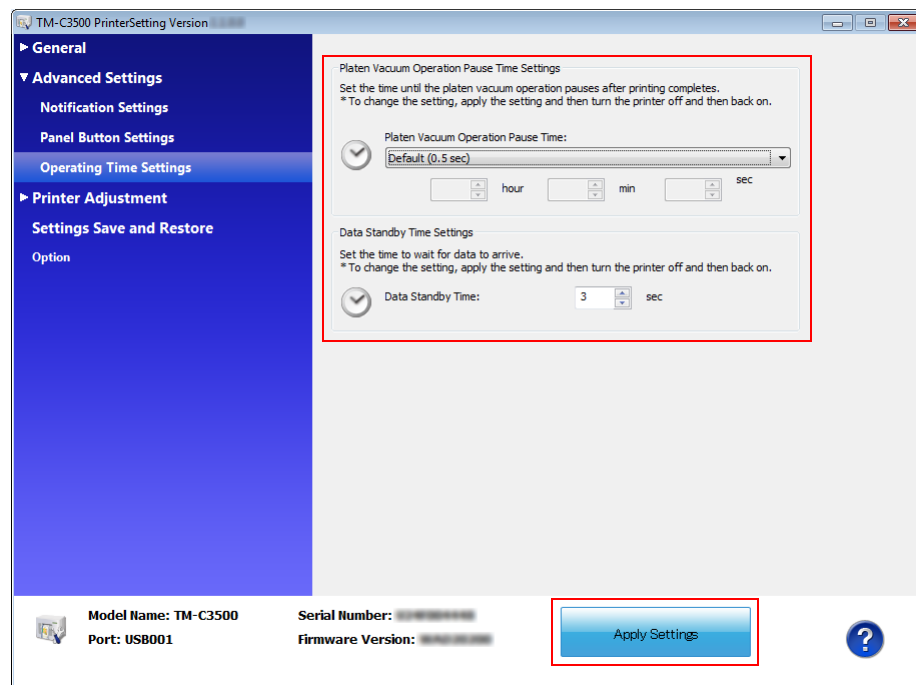

- 6 The confirmation window appears. Click (Yes) to send the settings to the printer.

Paper Feed Adjustment

Allows you to specify the following:

| Settings | Description |
|--|---|
| Cut Position Adjustment | Adjust the cut position. The unit is 1/180 inch. You can make adjustments in the range of -63 to 63. |
| Print Start Position Adjustment (Vertical Direction) | Adjust the print start position (vertical direction). The unit is 1/180 inch. You can make adjustments in the range of -63 to 63. |
| Print Start Position Adjustment (Horizontal Direction) | Adjust the print start position (horizontal direction). The unit is 1/180 inch. You can make adjustments in the range of -4 to 4. |

NOTE

The [dot] - [mm] - [inch] conversions for 180 dpi are as follows.

1dot - 0.1411 mm - 0.0055inch
2dot - 0.2822 mm - 0.0111inch
3dot - 0.4233 mm - 0.0166inch
4dot - 0.5644 mm - 0.0222inch
5dot - 0.7055 mm - 0.0277inch
6dot - 0.8466 mm - 0.0333inch
7dot - 0.9877 mm - 0.0388inch
8dot - 1.1288 mm - 0.0444inch
9dot - 1.2700 mm - 0.0500inch
10dot - 1.4111 mm - 0.0555inch

Adjustment Method

- 1 Turn the printer on.
- 2 Display the printer driver window.
(See "How to Display the Printer Driver" on page 43.)
- 3 Select (Printer Utilities) tab and click (Printer Setting Utility) under (Printer Preferences).
- 4 TM-C3500 PrinterSetting window appears. Select (Printer Adjustment)-(Paper Feed Adjustment).
- 5 "Paper Feed Adjustment" window appears. Specify each item. Then, click (Apply Settings).

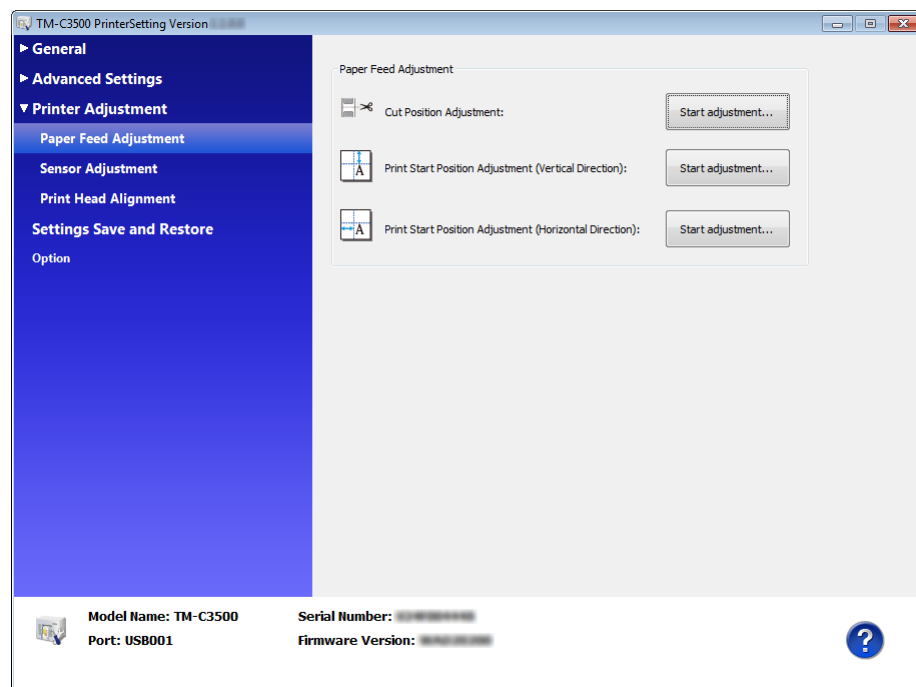

- 6 The confirmation window appears. Click (Yes) to send the settings to the printer.

Cut Position Adjustment

The paper feed pitch is adjusted as described below depending on the [Media detection settings].

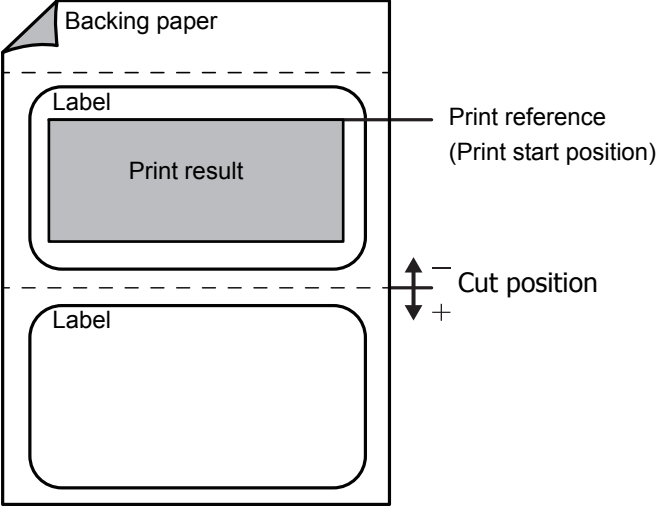
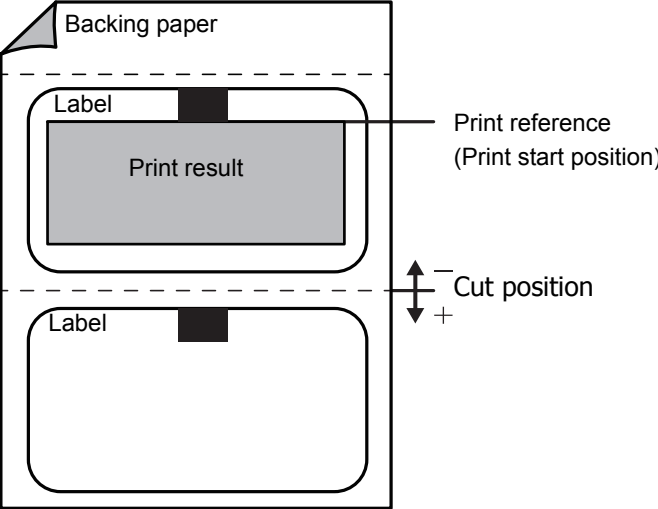
| Media detection settings | Description |
|--|---|
| <p>Die-cut label (Gap) Transparent die-cut label</p> | <ul style="list-style-type: none"> • Specifying a positive value moves the cut position closer to the reference position (print start position). • Specifying a negative value moves the cut position away from the reference position (print start position).  |
| <p>Die-cut label (Blackmark)</p> | <ul style="list-style-type: none"> • Specifying a positive value moves the cut position closer to the reference position (print start position). • Specifying a negative value moves the cut position away from the reference position (print start position).  |

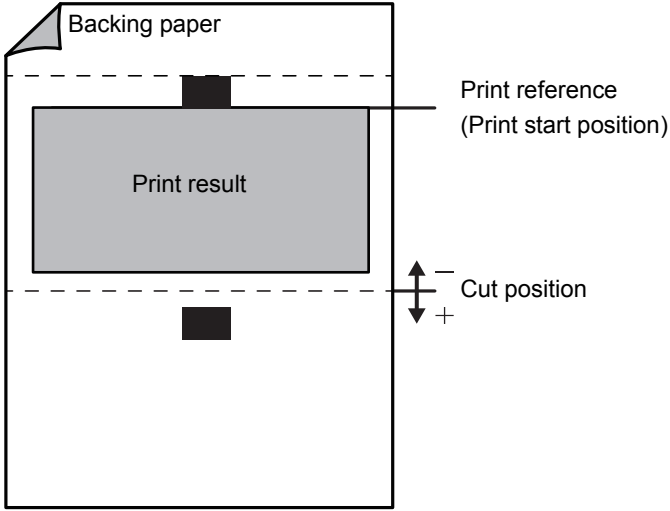
| Media detection settings | Description |
|------------------------------|--|
| Continuous paper (Blackmark) | <ul style="list-style-type: none">• Specifying a positive value moves the cut position closer to the reference position (print start position).• Specifying a negative value moves the cut position away from the reference position (print start position).  <p>The diagram illustrates the media detection settings for continuous paper. It shows a sheet of paper with a 'Backing paper' section at the top. A 'Print result' is shown as a shaded rectangle. A 'Print reference (Print start position)' is indicated by a dashed line and a black square above the print result. A 'Cut position' is indicated by a dashed line and a black square below the print result. A vertical double-headed arrow between the dashed lines is labeled 'Cut position' with a '-' sign above and a '+' sign below, indicating the distance between the reference and cut positions.</p> |

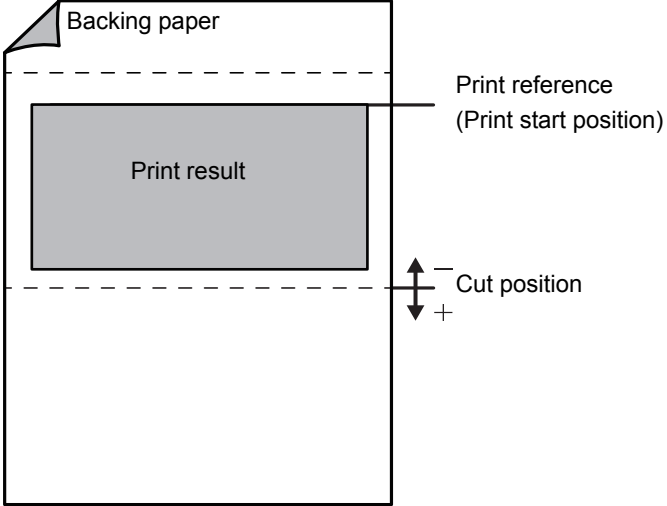
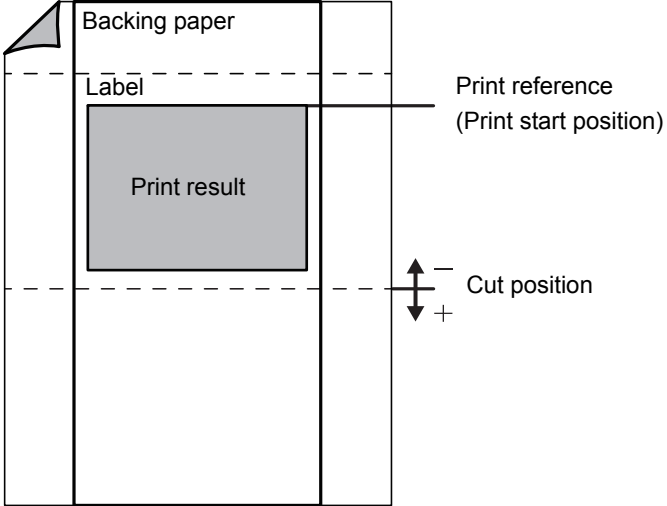
| Media detection settings | Description |
|--|---|
| Full-page label Continuous paper Transparent full-page label | <ul style="list-style-type: none"> • Specifying a positive value moves the cut position closer to the reference position (print start position). • Specifying a negative value moves the cut position away from the reference position (print start position).   |

Print Start Position Adjustment (Vertical Direction)

The paper feed pitch is adjusted as described below depending on the [Media detection settings].

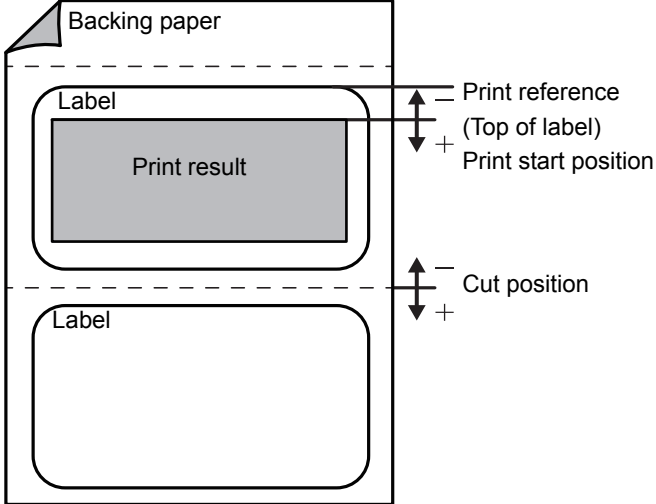
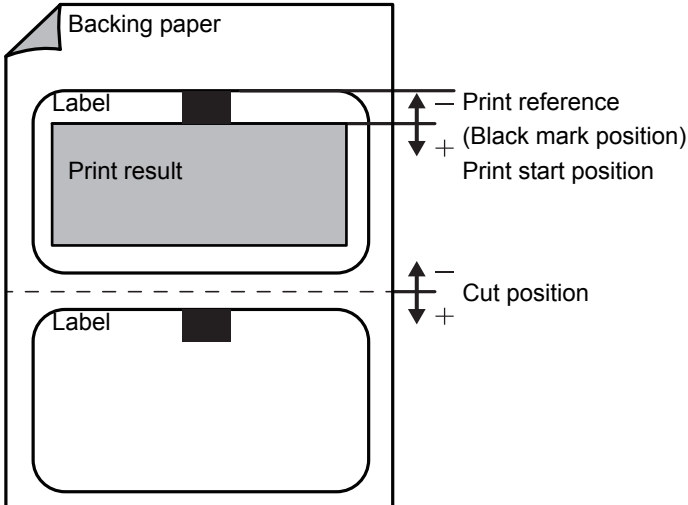
| Media detection settings | Description |
|--|---|
| <p>Die-cut label (Gap) Transparent die-cut label</p> | <ul style="list-style-type: none"> Specifying a positive value moves the print start position and cut position away from the reference position (top of label). Specifying a negative value moves the print start position and cut position closer to the reference position (top of label).  |
| <p>Die-cut label (Blackmark)</p> | <ul style="list-style-type: none"> Specifying a positive value moves the print start position and cut position away from the reference position (blackmark position). Specifying a negative value moves the print start position and cut position closer to the reference position (blackmark position).  |

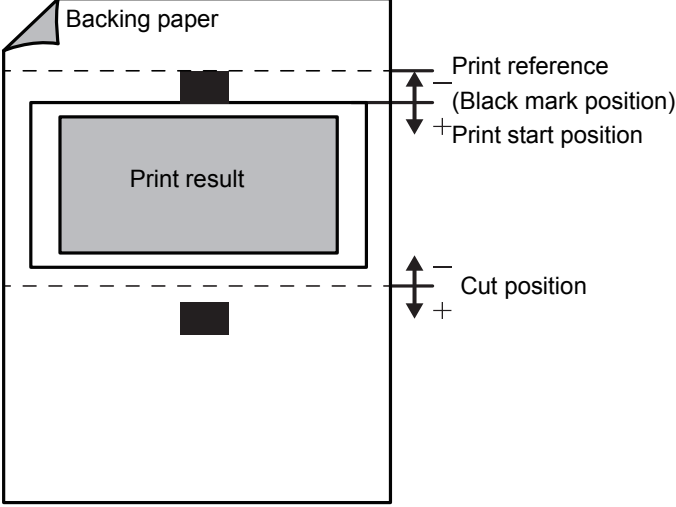
| Media detection settings | Description |
|--|--|
| Continuous paper (Blackmark) | <ul style="list-style-type: none"> • Specifying a positive value moves the print start position and cut position away from the reference position (blackmark position). • Specifying a negative value moves the print start position and cut position closer to the reference position (blackmark position).  <p>The diagram shows a sheet of paper with a 'Backing paper' label at the top left. A dashed horizontal line represents the 'Print reference (Black mark position)'. Below this line is a solid horizontal line representing the 'Print start position'. A double-headed vertical arrow between these two lines is labeled with a minus sign (-) above and a plus sign (+) below. Below the print start position is a shaded rectangular area labeled 'Print result'. Below the print result is another solid horizontal line representing the 'Cut position'. A double-headed vertical arrow between the print start position and the cut position is labeled with a minus sign (-) above and a plus sign (+) below.</p> |
| Full-page label Continuous paper Transparent full- page label | There are no adjustments. |

Sensor Adjustment

The threshold for the sensor can be adjusted when the sensor does not detect the label gap and black mark for the paper to be used. Follow the steps below to make adjustment.

- 1 Load the paper to the printer.
- 2 Turn the printer on.
- 3 Display the printer driver window.
(See "How to Display the Printer Driver" on page 43.)
- 4 Select (Printer Utilities) tab and click (Printer Setting Utility) under (Printer Preferences).
- 5 TM-C3500 PrinterSetting window appears. Select (Printer Adjustment) - (Adjustment).
- 6 "Sensor Adjustment" window appears. Click (Start adjustment) for the sensor to be adjusted.

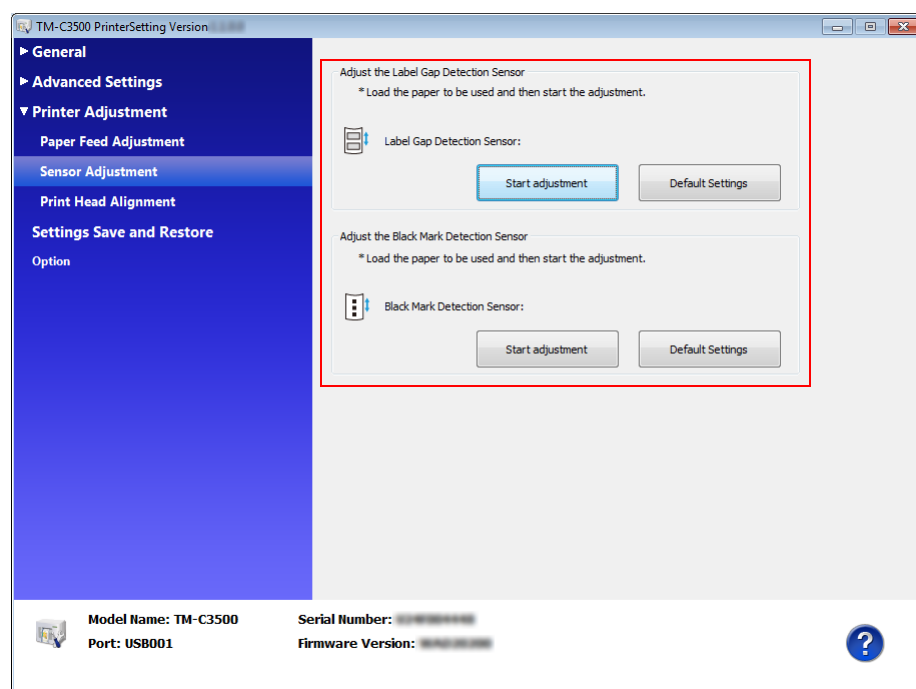

- 7 The confirmation window appears. Click (Yes) to send the settings to the printer.

Print Head Alignment

Adjust the print head alignment (gap) when vertical and horizontal lines appear misaligned or printed characters are blurred.

NOTE

The banding adjustment may not completely solve gaps between lines or prints over previous lines.

- 1 Turn the printer on.
- 2 Display the printer driver window.
(See "How to Display the Printer Driver" on page 43)
- 3 Select (Printer Utilities) tab and click (Printer Setting Utility) under (Printer Preferences).
- 4 TM-C3500 PrinterSetting window appears. Select (Printer Adjustment)-(Print Head Alignment).
- 5 "Print Head Alignment" window appears. Specify each item. Then, click (Apply Settings).

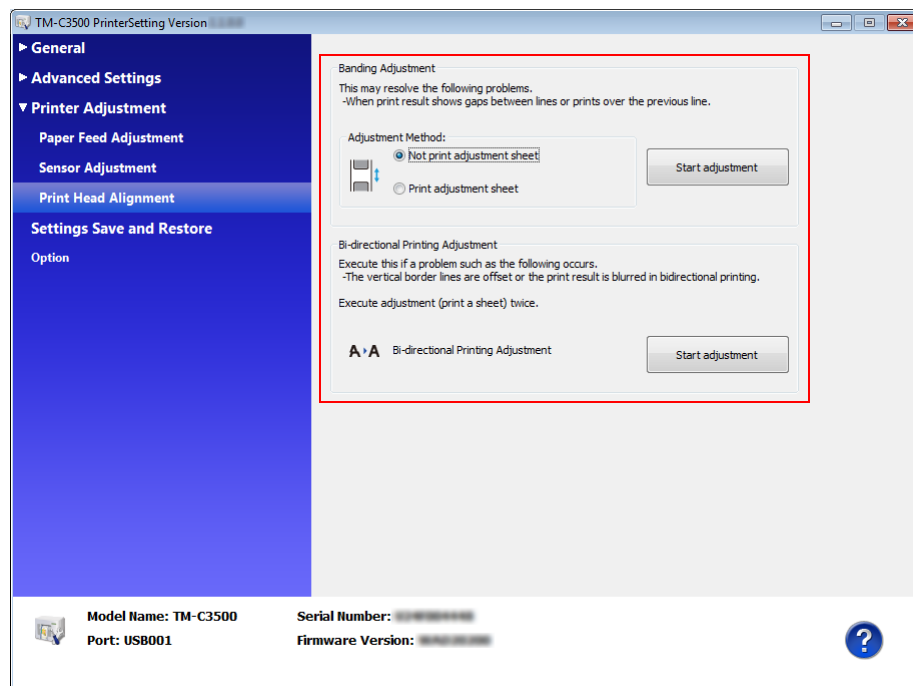

- 6 The confirmation window appears. Click (Yes) to send the settings to the printer.

Network Interface

The LAN interface information for this printer is as shown below.

The network setting can be checked by printing the status sheet. See "[Status Sheet Printing \(LAN interface model only\)](#)" on page 161.

Factory settings

The factory settings for this printer are as follows:

| Item | Factory settings |
|---------------------------------------|--|
| IP address setting mode ^{*1} | Manual / Auto |
| IP address | 192.168.192.168 ^{*2} |
| Host computer name | EPSONxxxxxx (xxxxxx sets the lowest 6 digits of the MAC address.) |
| Domain name | None |

*1:The factory settings differ depending on the model.

*2:Default value with "IP address setting mode" set to "Manual".

NOTE

The printer driver has no function to automatically follow the IP address set for the printer. If the printer is used with "IP address setting mode" set to "Auto", printing may be disabled. We recommend consulting with the network administrator in advance or setting the fixed IP address using any of various types of utilities (InstallNavi, EpsonNet Config, EPSON Deployment Tool, etc.). See "[Utilities and Manuals](#)" on page 175.

How to initialize the settings to the factory settings



Follow the steps below to initialize the LAN interface of this printer.

- 1 Make sure that the printer is turned off.
- 2 Turn the power on while pressing the STATUS SHEET button; then continue to press the status sheet button for ten seconds or more. The settings for the LAN interface can be changed to the factory settings.

Troubleshooting

Trouble Recovery Method

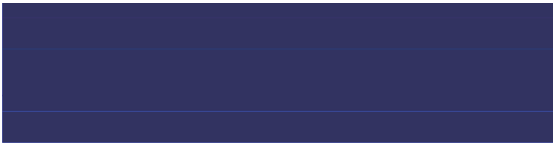
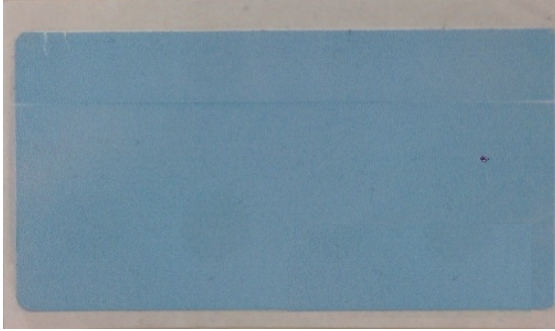
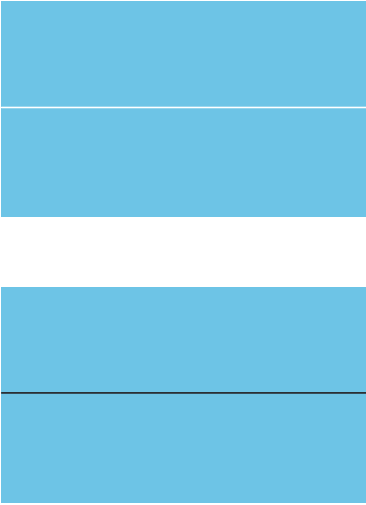
Trouble status (Image/Illustration)

| No.1 | No.2 |
|---|--|
|  |  |
| No.3 | No.4 |
|  |  |

| Trouble | Description | Recovery method | Image/ Illustration |
|--|--|--|------------------------|
| An error has occurred | The LCD displays the content of the error. | See " Error Recovery Method " on page 151 . | - |
| The print result is faded or has lines (black/white) (Lines printed while feeding by 25.4 mm/1 inch could be improved; however, you cannot remove them completely.) | There are missing dots. | Perform nozzle check and check whether print nozzles are clogged. If the print nozzles are clogged, perform head cleaning. Hold down the cleaning button for more than three seconds to start head cleaning. When (Printing operation mode) is set to other than (Anti-missing Dot mode), missing dots are permitted. When no missing dots can be permitted, change (Printing operation mode) to (Anti-missing Dot mode). See " Nozzle Check Mode Settings " on page 117 . | No. 1 |
| | The shutters on the platen on the outer side of the paper are set to open. | When the shutters on the platen on the outer side of the paper are set to open, air current may cause printing trouble, and white lines may be printed. Follow the instructions on the label on the top of the printer, and set the shutters on the platen. See " Shutter Adjustment " on page 40 . | No. 2 |
| | The paper you are using differs from the paper set in the (Media Type). | Check the paper you are using and the (Media Type) settings. For more information, see step 9 in " Replacing Roll Paper with Fanfold Paper " on page 66 , or step 10 in " Replacing Fanfold Paper with Roll Paper " on page 75 . | - |

| Trouble | Description | Recovery method | Image/ Illustration |
|---|---|--|---------------------|
| <p>The print result is faded or has lines (black/ white) (Lines printed while feeding by 25.4 mm/1 inch could be improved; however, you cannot remove them completely.)</p> | <p>As the paper feeding amount varies depending on the paper being used, white lines or black lines may be printed.</p> | <p>Adjust the alignment of paper feed. On the (Printer Utilities) tab, click (Printer Setting Utility). When the PrinterSetting screen is displayed, click (Printer Adjustment) - (Print Head Alignment), and perform (Bi-directional Printing Adjustment). See the following for details. "How to Make Media Settings" on page 172 "Print Head Alignment" on page 136</p> | <p>No. 3</p> |
| | <p>(Banding Reduction) is not selected.</p> | <p>When the paper type is set to other than (Plain) or (Plain label), select (Banding Reduction) to reduce black lines or white lines when printing. On the (General) tab, select (Advanced) from (Print Settings), click (Advanced...), and then select (Banding Reduction). When you select this, printing speed may decline.</p> | <p>No. 3</p> |
| | <p>(Quality) is not selected in (Print Quality).</p> | <p>When the paper type is set to other than (Plain) or (Plain label), select (Quality) to reduce black lines or white lines when printing. From the printer driver's (Print Settings), set (Print Quality) to (Quality). When you select this, printing speed may decline.</p> | <p>No. 3</p> |
| | <p>Roll paper is not loaded correctly.</p> | <p>Open the roll paper cover, and load the roll paper again. For details, see "Replacing Roll Paper with Fanfold Paper" on page 66.</p> | <p>-</p> |
| | <p>Fanfold paper is not loaded correctly.</p> | <p>Place the stack of fanfold paper straight at least 40 mm away from the back of the printer. For details, see "Replacing Fanfold Paper with Roll Paper" on page 75.</p> | <p>No. 3</p> |

| Trouble | Description | Recovery method | Image/ Illustration |
|--|---|---|------------------------|
| Print results look different from what was expected | If you have moved the printer after the initial ink charge, specified colors may not be produced (colors may be mixed) due to vibration or impacts. | Perform manual head cleaning until there are no more mixed colors. Hold down the cleaning button for more than three seconds to start head cleaning. | No. 4 |
| Print results are blurry | Print results may be blurry depending on the thickness of the paper being used. | Adjust the misalignment of bidirectional printing. On the (Printer Utilities) tab, select (Printer Setting Utility). When the PrinterSetting screen is displayed, click (Printer Adjustment) - (Print Head Alignment) - (Bi-directional Printing Adjustment). See " Print Head Alignment " on page 136. | - |
| Left and right sides of the print result are blurry. | The shutters on the platen on the outer side of the paper are set to open. | When the shutters on the platen on the outer side of the paper are set to open, air current may cause printing trouble; outer edges of the print result may become blurry. Follow the instructions on the label on the top of the printer, and set the shutters on the platen. See " Shutter Adjustment " on page 40. | No. 4 |
| The print result is misaligned laterally. | Paper is not loaded in the center. | If the paper is loaded out of the central position, print results may be misaligned laterally right after the media is loaded. Use the media guide to load the paper in the central position, or feed the paper first and then start printing. | - |
| | The paper is close to the rear edge. | When the paper is close to the rear edge, the print results may be misaligned laterally or become blurred. Replace the paper. | - |

| Trouble | Description | Recovery method | Image/ Illustration |
|-------------------------------------|--|--|------------------------|
| Print quality for bar-codes is poor | The shutters on the platen on the outer side of the paper are set to open. | When the shutters on the platen on the outer side of the paper are set to open, air current may cause printing trouble; outer edges of the print result may become blurry. Follow the instructions on the label on the top of the printer, and set the shutters on the platen. See " Shutter Adjustment " on page 40. | No. 4 |
| | The paper you are using differs from the paper set in the (Media Type). | Check the paper you are using and the (Media Type) settings. For more information, see step 9 in " Replacing Roll Paper with Fanfold Paper " on page 66, or step 10 in " Replacing Fanfold Paper with Roll Paper " on page 75. | - |
| | The resolution for the printer and print data do not match. | If the resolution for the printer and print data do not match, barcodes may not be printed correctly. Match the resolution for the printer and print data. For TM-C3500, the resolution for print data is set to 360 dpi for all (Print Settings). For more information on the barcode generator application you are using, see the manual supplied with the application. | - |

| Trouble | Description | Recovery method | Image/ Illustration |
|------------------------------------|---|--|------------------------|
| Print quality for barcodes is poor | The width of the bars has not been corrected. | <p>The width of the bars has to be corrected to print barcodes correctly. Use the barcode and 2D symbol fonts that are installed with the printer driver, or a barcode generator application to correct the width of bars.</p> <p>To be more precise, decrease one pixel from the bars and increase one pixel for the space between bars. For more information on the barcode generator application you are using, see the manual supplied with the application.</p> <p>The width of the bars is not corrected for the 2D symbols.</p> | No. 4 |
| | Depending on the paper you are using, ink amount used to maintain the barcode print quality may vary. | <p>Set (Ink Profile).</p> <p>On the (General) tab, select (Advanced) from (Print Settings), click (Advanced...) and then select (Ink Profile and Brightness Adjustment). Set (Ink Profile) correctly. For appropriate (Ink Profile) settings, contact your dealer. (See "How to Make Media Settings" on page 172.)</p> <p>You can also use the BSF file to set (Ink Profile). See "Exporting/Importing Printer Driver Settings" on page 87.</p> | - |
| | The print result may be blurry depending on the thickness of the paper being used. | <p>Adjust the misalignment of bidirectional printing.</p> <p>On the (Printer Utilities) tab, select (Printer Setting Utility). When the PrinterSetting screen is displayed, click (Printer Adjustment) - (Print Head Alignment) - (Bi-directional Printing Adjustment).</p> <p>See "Print Head Alignment" on page 136.</p> | - |

| Trouble | Description | Recovery method | Image/ Illustration |
|------------------|--|--|------------------------|
| Paper is smudged | The paper width and the settings for the shutters on the platen do not match. | <p>When the paper width and the settings for the shutters on the platen do not match, paper may be lifted; the print head may touch and smudge the paper.</p> <p>Follow the instructions on the label on the top of the printer, and set the shutters on the platen.</p> <p>See "Shutter Adjustment" on page 40.</p> | - |
| | The paper you are using differs from the paper set in the (Media Type). | <p>Check the paper you are using and the (Media Type) settings.</p> <p>For more information, see step 9 in "Replacing Roll Paper with Fanfold Paper" on page 66, or step 10 in "Replacing Fanfold Paper with Roll Paper" on page 75.</p> | - |
| | If the print head has foreign objects attached, the paper may be smudged. | <p>Perform manual head cleaning.</p> <p>Hold down the cleaning button for more than three seconds to start head cleaning.</p> | - |
| | The print head may touch the paper and the paper may become smudged because the platen's suction may be insufficient for some paper you are using. | <p>Set (Platen Vacuum Manual Adjustment).</p> <p>On the printer driver's (Options) tab, set (Platen Vacuum Manual Adjustment).</p> <p>You can also use the BSF file to set (Platen Vacuum Manual Adjustment). See "Exporting/Importing Printer Driver Settings" on page 87.</p> | - |

| Trouble | Description | Recovery method | Image/ Illustration |
|--|---|---|------------------------|
| Auto Fit Page is not available | The Auto Fit Page function is available for TM-C3400, but it is not available for TM-C3500. | <p>For thermal label printers, the label size is generally considered as "printable area", however for TM-C3400, it is considered as "label size" - "margins" = printable area.</p> <p>Therefore, TM-C3400 comes with the Auto Fit Page function so that the same paper layout can be used even when the printable area is smaller.</p> <p>To be more precise, when (Auto Fit Page) is enabled, the size including the margins is reduced to fit the printable area.</p> <p>For TM-C3500, enable (Borderless Printing) to match the "label size" and "printable area".</p> <p>Enable (Borderless Printing) if you want to use the same paper layout as for the thermal label printer.</p> | - |
| The print position is misaligned | The paper you are using differs from the paper set in the (Media Layout). | <p>If the paper you are using differs from the paper set in the (Media Layout), the image may not be printed at the correct position.</p> <p>Set Media Layout correctly.</p> <p>For more information, see step 9 in "Replacing Roll Paper with Fanfold Paper" on page 66, or step 10 in "Replacing Fanfold Paper with Roll Paper" on page 75.</p> | - |
| The label size and printable area do not match | It is product specifications | <p>On the (General) tab, if you select (User Defined...) in Media Layout but do not select (Borderless Printing), the area minus the 1.5 mm margins around the label becomes the printable area.</p> <p>Enable (Borderless Printing) if you want to use the whole label size as the printable area.</p> <p>When (Borderless Printing) is enabled, images may be printed on the backing paper; therefore, remove the 1.5 mm margin on all edges from the print data.</p> | - |

| Trouble | Description | Recovery method | Image/ Illustration |
|--|--|--|------------------------|
| I want to perform borderless printing | - | <p>To perform borderless printing, use the label that is cut in half and still has edge cutoffs. Specify a printable area that is larger than the actual label size and print.</p> <p>See "Setting the label size and paper layout for borderless printing" on page 170 on page.</p> | - |
| Print position and cut position are misaligned | The print position may be misaligned depending on the paper you are using. | <p>Adjust the position.</p> <p>On the printer driver's (Printer Utilities) tab, click (Printer Setting Utility). When the PrinterSetting screen is displayed, click (Printer Adjustment) and perform (Paper Feed Adjustment).</p> <p>You can perform (Cut Position Adjustment) (Print Start Position Adjustment (Vertical Direction)), and (Print Start Position Adjustment (Horizontal Direction)).</p> <p>See "Paper Feed Adjustment" on page 128.</p> | - |

| Trouble | Description | Recovery method | Image/ Illustration |
|--|---|---|------------------------|
| <p>When paper is loaded, it is fed and an error occurs</p> <p>For Full-page label, Continuous paper, and Transparent full-page label</p> | <p>The paper you are using does not match the (Media detection settings).</p> | <p>Check the paper you are using and the printer's (Media detection settings). See "Media detection settings" on page 114.</p> | - |
| | <p>An error has occurred in the sensor.</p> | <p>If the printer has been working properly so far, the sensor may be malfunctioning. Contact your dealer for repairs.</p> | - |
| | <p>Label gap detection is not available for fan-fold paper</p> | <p>For fanfold paper, backing paper thicker than that of roll paper is used to avoid paper jam. Therefore, the gap may not be detected even when you are using genuine Epson paper. If this happens, click (Printer Setting Utility) on the (Printer Utilities) tab in the printer driver to display the Printer Setting Utility window. Select (Printer Adjustment) - (Sensor Adjustment) - (Adjust the Label Gap Detection Sensor). For details, see "Sensor Adjustment" on page 135. If the gaps are still not detected even after adjusting the sensor, change the detection method to using black marks.</p> | - |

| Trouble | Description | Recovery method | Image/ Illustration |
|---|---|---|------------------------|
| <p>When paper is loaded, it is fed and an error occurs</p> <p>For Die-cut label (Gap) and Transparent die-cut label</p> | <p>The paper you are using does not match the (Media detection settings).</p> | <p>Check the paper you are using and the printer's (Media detection settings).</p> <p>See "Media detection settings" on page 114.</p> | - |
| | <p>The transmittance of the paper you are using is out of the specifications.</p> | <p>The label gap may not be detected. Infrared light is used to detect the label gap; therefore, the infrared transmittance of the backing paper must be higher than the specified value and that of the label part must be lower than the specified value.</p> <p>Check the paper specifications, and use the paper that matches the printer specifications.</p> <p>You may be able to detect the gap by performing (Adjust the Label Gap Detection Sensor).</p> <p>On the printer driver's (Printer Utilities) tab, click (Printer Setting Utility). When the PrinterSetting screen is displayed, click (Printer Adjustment) - (Sensor Adjustment) and perform (Adjust the Label Gap Detection Sensor).</p> <p>See "Sensor Adjustment" on page 135.</p> | - |
| | <p>An error has occurred in the sensor.</p> | <p>If the printer has been working properly so far, the sensor may be malfunctioning. Contact your dealer for repairs.</p> | - |

| Trouble | Description | Recovery method | Image/ Illustration |
|--|---|---|------------------------|
| <p>When paper is loaded, it is fed and an error occurs</p> <p>For Die-cut label (Blackmark) and Continuous paper (Blackmark)</p> | <p>The paper you are using does not match the (Media detection settings).</p> | <p>Check the paper you are using and the printer's (Media detection settings).</p> <p>See "Media detection settings" on page 114.</p> | - |
| | <p>Black marks are out of the specifications.</p> | <p>The black marks may not be detected if their reflection rate is higher than the specified value. Infrared light is used to detect the black marks; therefore, the reflection rate for the infrared light must be lower than the specified value. Check the black mark printing specifications, and use the black marks that match the printer specifications. You may be able to detect the black marks by performing (Adjust the Black Mark Detection Sensor).Click (Printer Setting Utility) on the printer driver's (Printer Utilities) tab. When the Printer-Setting screen is displayed, click (Printer Adjustment) - (Sensor Adjustment) and perform (Adjust the Black Mark Detection Sensor).See "Sensor Adjustment" on page 135.</p> | - |
| | <p>An error has occurred in the sensor.</p> | <p>If the printer has been working properly so far, the sensor may be malfunctioning. Contact your dealer for repairs.</p> | - |
| <p>I want to use the large-diameter roll paper supply unit and take-up unit</p> | - | <p>Use the large-diameter roll paper supply unit and take-up unit that match the printer specifications.</p> <p>For the specifications of the large-diameter roll paper supply unit and take-up unit, see "TM-C3400/C3500 Series Design Manual for Media Take-up Unit".</p> <p>For more information on "TM-C3400/C3500 Series Design Manual for Media Take-up Unit", contact your dealer.</p> | - |

| Trouble | Description | Recovery method | Image/ Illustration |
|---|-------------|---|------------------------|
| I do not know how to load the large-diameter roll paper | - | <p>See "TM-C3400/C3500 Series Design Manual for Media Take-up Unit".</p> <p>On the (Printer Utilities) tab, select (Printer Setting Utility).</p> <p>(2) Select (Option) and (Enable Selection of Large-diameter roll paper (Use the Rear Feed Slot)) in (Media Source Settings Option).</p> <p>(3) Select (General) - (Media Settings) - (Media source settings) - (Large-diameter roll paper (Use the Rear Feed Slot)).</p> <p>For more information on "TM-C3400/C3500 Series Design Manual for Media Take-up Unit", contact your dealer.</p> | - |

Error Recovery Method

The following table shows the error recovery methods.

| LCD display | Description | Recovery method |
|---|---|--|
| MEDIA FORM ERROR | The type of the paper set in the printer is different from the specified type set for "Media detection settings". | <ul style="list-style-type: none"> Set the type of paper specified for "Media detection settings". Change the settings for "Media detection settings" to that is suitable for the loaded paper. For more information on the confirmation method and how to make settings for Media detection settings, see "Media detection settings" on page 114 |
| MEDIA SIZE ERROR | The paper size is inappropriate for the print area. | <ul style="list-style-type: none"> Set the paper whose size matches the print area. Change the print area to that suitable for the loaded paper. |
| PAPER JAM ERR ## ##:59 | Roll paper is installed to the printer set on fanfold paper. | <p>Set the type of paper specified for "Media source".</p> <p>Set the paper, "Replacing Roll Paper with Fanfold Paper" on page 66 or "Replacing Fanfold Paper with Roll Paper" on page 75.</p> |
| PAPER JAM ERR ## ##:01 to 0E, 44, 55 to 5C, 80 | The paper is jammed. | <p>Check the paper path for a paper jam. If jammed paper is found, remove it completely.</p> <p>Set the paper, "Replacing Roll Paper with Fanfold Paper" on page 66 or "Replacing Fanfold Paper with Roll Paper" on page 75.</p> |
| PAPER JAM ERR ## ##: 81 | Fanfold paper is loaded when the media settings are set to roll paper. | <p>Load the paper that matches the media settings.</p> <p>For details on how to load paper, see "Replacing Roll Paper with Fanfold Paper" on page 66 or "Replacing Fanfold Paper with Roll Paper" on page 75.</p> |
| PAPER REMOVAL ER | Fanfold paper is inserted when fanfold paper still remains in the printer. | Pull out the fanfold paper that remains in the paper exit. insert fanfold paper into the fanfold paper slot at the back of the printer. |
| PAPER OUT | Paper is out. | Set the paper, "Replacing Roll Paper with Fanfold Paper" on page 66 or "Replacing Fanfold Paper with Roll Paper" on page 75 . |
| PAPER OUT ERROR | Paper is out. | |
| ROLL COVER OPEN | The roll paper cover is open. | Close the roll paper cover. |
| INK COVER OPEN | The ink cartridge cover is open. | Close the ink cartridge cover. |

| LCD display | Description | Recovery method |
|----------------------------------|---|---|
| NO INK CARTRIDGE | An ink cartridge is not loaded. | Load an ink cartridge with sufficient ink left. See "Replacing the Ink Cartridge" on page 61. |
| INK READ ERROR | The ink cartridge information could not be read. | <ul style="list-style-type: none"> Remove the ink cartridge. Load the ink cartridge again. If the error occurs again, replace the ink cartridge with a new one. See "Replacing the Ink Cartridge" on page 61. |
| M/B COVER OPEN | The maintenance box cover is open. | Close the maintenance box cover. |
| NO MAINT BOX | The maintenance box is not loaded. | Load a maintenance box with sufficient space. See "Replacing Maintenance Box" on page 64. |
| M/B READ ERROR | The maintenance box information could not be read. | <ul style="list-style-type: none"> Remove the maintenance box. Load the maintenance box again. If the error occurs again, replace the maintenance box with a new one. See "Replacing Maintenance Box" on page 64. |
| REPLACE INK | It is time to replace the ink cartridge. | Load an ink cartridge with sufficient ink. See "Replacing the Ink Cartridge" on page 61. |
| REPLACE MAINT B | It is time to replace the maintenance box. | Load a maintenance box with sufficient space. See "Replacing Maintenance Box" on page 64. |
| NOZZLE CLOGGED | A nozzle clog that cannot be recovered. | Check the printing result, and if the nozzle clog cannot be permitted, perform repairs. |
| CUT UNAVAILABLE | Autocutting is being performed 2 or more times with the paper in the same position. | To prevent pieces of paper, autocutting cannot be performed twice or more without feeding the paper. Autocutting is unnecessary. |
| SERVICE SOON ## | The product is near the end of its service life. | Because the internal parts of the printer are near the end of their service life, prepare to replace the printer, or prepare a printer for replacement. |
| PRINTER ERROR ## ##: 7B or 7C | Environmental temperature is out of spec. | Environmental temperature is too low (7B) or too high (7C). Set operating temperature from 10 to 35°C {50 to 95°C}. Turn on the power again. |

| LCD display | Description | Recovery method |
|---|--|--|
| PRINTER ERROR ## ##: 20 to 54, 64 to 75, A9, B0 to DA | Paper jam Poor autocutter operation Irregular ambient temperature Malfunction | 1. Turn the printer off. 2. Open the roll paper cover. 3. Check the paper path for a paper jam. If jammed paper is found, remove it completely. 4. Set a paper. 5. Turn the printer on. If the error occurs again, perform repairs. |
| SERVICE REQD. ## ##: A0 to A3 | The product is beyond its service life. | Perform repairs. |
| Failure in firmware updating | Failed to update the firmware. | Turn the power on again, and if the error occurs again, perform repairs. |

When the print result is faint or white lines or black lines are printed

Follow the steps below to clear the problem efficiently.

| | |
|--|--|
| <p>Check if the paper is loaded correctly.</p> | <ul style="list-style-type: none"> • For roll paper: Open the roll paper cover, and load the paper again. For details, see "Replacing Fanfold Paper with Roll Paper" on page 75. • For fanfold paper: Place the stack of fanfold paper straight at least 40 mm {1.57"} away from the back of the printer. For details, see "Replacing Roll Paper with Fanfold Paper" on page 66. |
|--|--|



| | |
|--|---|
| <p>Check if the print nozzles are clogged.</p> | <p>Perform nozzle check and check whether print nozzles are clogged. If the print nozzles are clogged, perform head cleaning. Hold down the cleaning button for more than three seconds to start head cleaning.</p> |
|--|---|



| | |
|---|---|
| <p>Check if the shutters on the platen on the outer side of the paper are open.</p> | <p>When the shutters on the platen on the outer side of the paper are set to open, air current may cause white lines on the print result. Follow the instructions on the label on the top of the printer, and set the shutters on the platen. For details, see "Shutter Adjustment" on page 40.</p> |
|---|---|



| | |
|--|--|
| <p>Check if the paper you are using matches the paper set in (Media Type).</p> | <p>Check the paper you are using and the (Media Type) settings. For details, see step 9 in "Replacing Roll Paper with Fanfold Paper" on page 66, or step 10 in "Replacing Fanfold Paper with Roll Paper" on page 75.</p> |
|--|--|



| | |
|---|---|
| <p>Correct the paper feeding misalignment</p> | <p>The paper feeding amount changes depending on the paper you are using, and it may cause white lines or black lines to be printed. On the printer driver's (Printer Utilities) tab, click (Printer Setting Utility). When the PrinterSetting screen is displayed, click (Printer Adjustment) - (Print Head Alignment), and per-form (Banding Adjustment). For details, see the following: "How to Make Media Settings" on page 172 "Print Head Alignment" on page 136</p> |
|---|---|



| | |
|-----------------------------|---|
| Select (Banding Reduction). | When the paper type is set to other than (Plain) or (Plain Label), select (Banding Reduction) to reduce black lines or white lines when printing. On the printer driver's (General) tab, select (Advanced) from (Print Settings), click (Advanced...), and then select (Banding Reduction). When you select this, printing speed may decline. |
|-----------------------------|---|



| | |
|--------------------------------------|---|
| Select (Quality) in (Print Quality). | When the paper type is set to other than (Plain) or (Plain Label), select (Quality) to reduce black lines or white lines when printing. From the printer driver's (Print Settings), set (Print Quality) to (Quality). When you select this, printing speed may decline. |
|--------------------------------------|---|



| | |
|--|--|
| Contact your dealer if the problem is still not resolved even after you have performed the operations above. | |
|--|--|

When the printer is not found even if EpsonNet Config is started

When the printer is not found even if EpsonNet Config is started, follow the steps below.

- 1** Restart EpsonNet Config.
Exit EpsonNet Config without pressing the [Refresh] button and then start it again.
- 2** Wait 30 seconds.
- 3** If the printer is not found after 30 seconds have passed, repeat Step 1 to 2.
If the problem is not solved even if the steps are repeated about 5 times, check the LAN cable connections and whether the Link LED on the lower rear side of the printer is on.
See "[Back](#)" on page 15.

HELP for EPSON Printers

You can view the help for the driver to handle errors.

Follow the steps below to display the troubleshooting for the driver's LCD display.

- 1 Display the printer driver window.
(See "How to Display the Printer Driver" on page 43.)
- 2 Click (Help) at the bottom-right of the window.

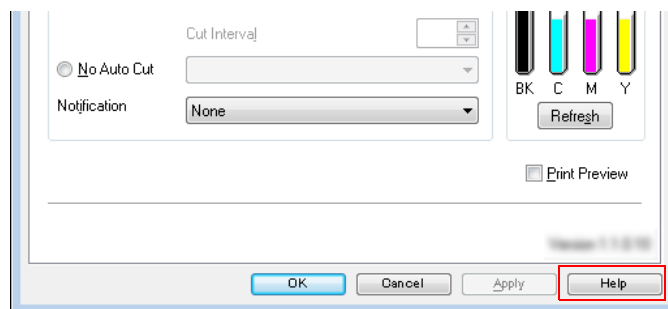

- 3 "HELP for EPSON Printers" window appears. From the top page, select (Introduction) - (Error Recovery to LCD Display).
Click [Home] to display the top page.

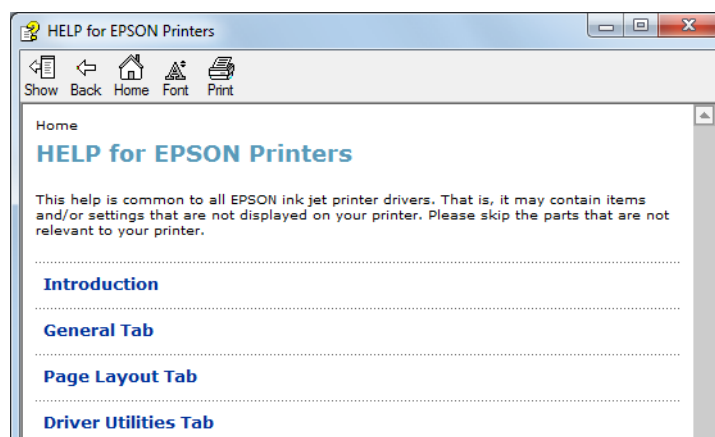

4 "Error Recovery to LCD Display" appears.

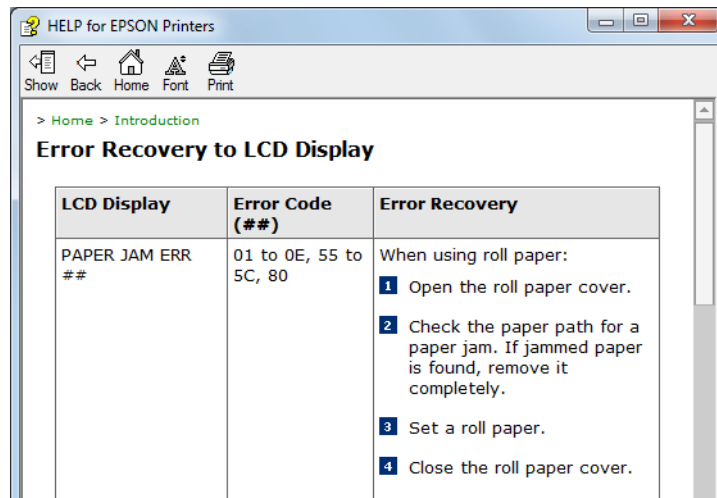

Setting Check Modes

Besides the ordinary print mode, the printer has the self-test mode and allows you to print the status sheet to check the various settings of the printer.

Self-test Mode

Printing errors such as dot missing can be checked on self-test mode. In addition, the firmware version, Post-Printing Verification Settings, and Media detection settings can be checked.

Follow the steps below to run the self-test.

- 1 Set the die-cut label, receipt or continuous label which length is 90 mm or more.
- 2 Turn the power on while pressing the paper feed button. (Keep pressing the Power switch until the POWER LED is on.)

Following test pattern is printed.

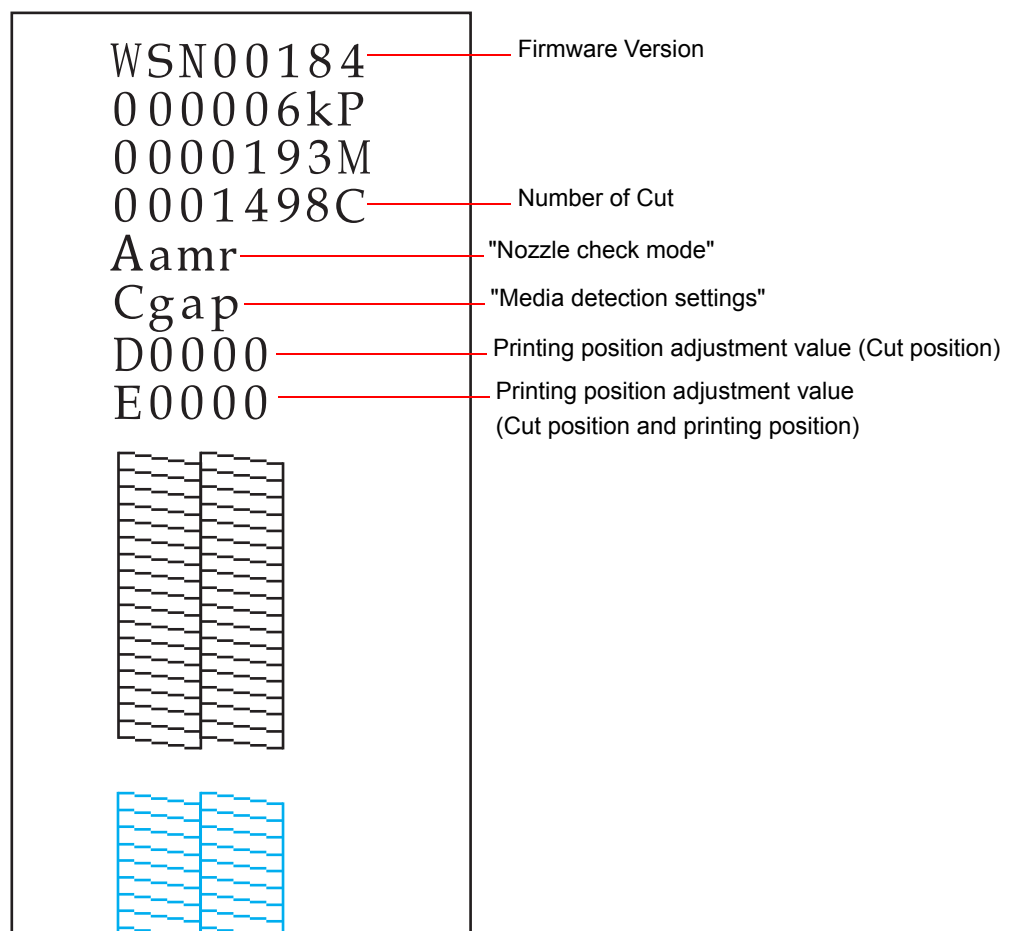

| Status | | Specification |
|---------------|----------|--|
| Number of Cut | 9999999C | Firmware version "WAD*****" is not printed |

| Status | | Specification |
|--------------------------|------|--|
| Nozzle check mode | Aamd | Anti-missing Dot Mode |
| | Aamr | Anti-missing Read Mode |
| | Aamc | Anti-missing Color Mode |
| | Anod | No Missing Dot Detection Mode |
| Media detection settings | Cnod | Full-page label/Continuous paper/Transparent full-page label |
| | Cbmd | Die-cut label (Blackmark) |
| | Cbmc | Continuous paper (Blackmark) |
| | Cgap | Die-cut label (Gap)/Transparent die-cut label |

Status Sheet Printing (LAN interface model only)

Network setting can be checked by printing the status sheet for the LAN interface model.

Following status sheet is printed when pressing the status sheet button on the rear of the printer.

NOTE

The network setting can be reset to the default value by turning on the printer while pressing the status sheet button and holding the button down for 20 seconds or more.

| EPSON Network Status Sheet | | |
|----------------------------|-----------------------------|---|
| 1. MAC Address | XX : XX : XX : XX : XX : XX | |
| 2. HW/SW Version | XX . XX/XX . XX | |
| 3. Network Status | Auto (100Base Full) | Auto (10 Base Full/10 Base Half/100 Base Full/ 100 Base Half)/10 Base Full/10 Base Half/100 Base Full/100 Base Half |
| 4. Port Type | Auto | Auto/MDI/MDI-X |
| 5. Get IP Address | Manual | Auto/Manual |
| 6. IP Address | XXX . XXX . XXX . XXX | |
| 7. Subnet Mask | XXX . XXX . XXX . XXX | |
| 8. Default Gateway | XXX . XXX . XXX . XXX | |
| 9. APIPA | Disable | Enable/Disable |
| 10. Set using PING | Disable | Enable/Disable |
| 11. DNS Address | Disable | Enable/Disable |
| | XXX . XXX . XXX . XXX | |
| | XXX . XXX . XXX . XXX | |
| | XXX . XXX . XXX . XXX | |
| 12. UPnP | Disable | Enable/Disable |
| 13. Bonjour | Disable | Enable/Disable |
| 14. Port Control LPR | Enable | Enable/Disable |
| Port 9100 | Enable | Enable/Disable |
| 15. Printing Control | Disable | Enable/Disable |
| 16. Time Server | Disable | Enable/Disable |
| 17. Idle Timeout LPR | XXXX sec | |
| Port 9100 | XXXX sec | |

Reset

The printer resets in the following cases (called "hardware reset"):

- ❑ When the printer is initialized with the RESET button
- ❑ After the printer's firmware is updated

Cleaning the Printer

Cleaning the platen

When replacing the maintenance box, use the non-woven cloth and cotton swabs included in the maintenance box and clean the platen in the following procedure.



- Do not use any water or alcohol.
- Be careful not to change the shutter positions on the platen. If the shutter is set incorrectly, paper may be jammed or get dirty.
- Be careful not to disfigure or damage the 3 sensors.

- 1** Turn off the printer and unplug the AC cable from the outlet.
- 2** Press down the release lever, and pull it to the front to open the roll paper cover.

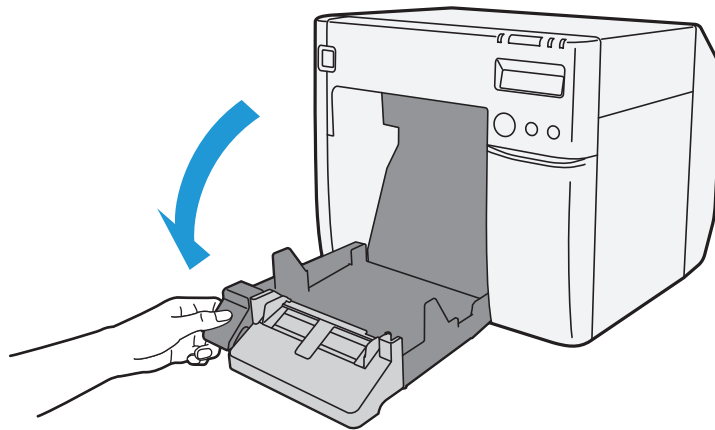

- 3** Remove the used roll paper or fanfold paper.

- 4 Use the non-woven cloth included with the maintenance box to wipe off stains on the platen.

NOTE

Your hands or paper may be stained by the ink on the platen. If the three holes in the platen are clogged with ink, ink stains may occur inside the printer.

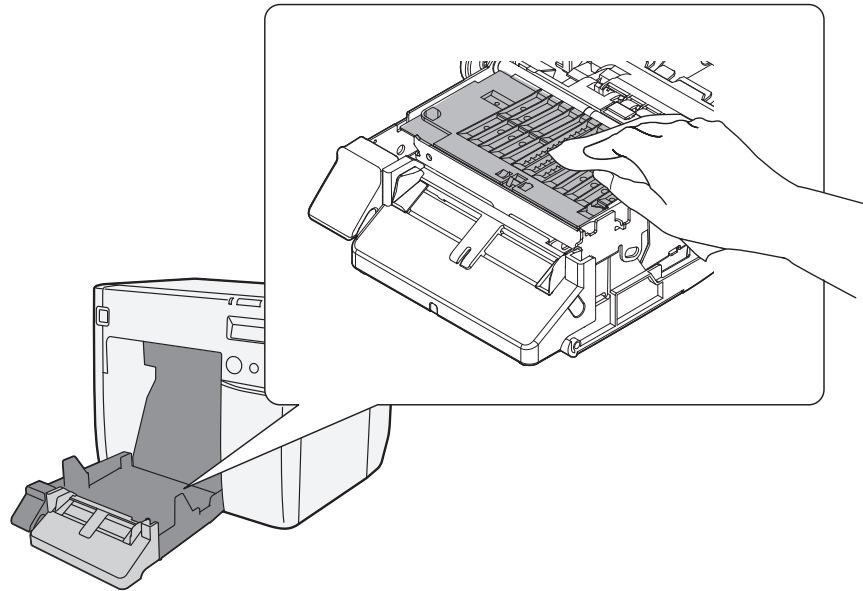

- 5 Use the included cotton swabs to remove stains in the holes or on the sides. If the holes are clogged, be sure to remove the stains and clean them thoroughly.

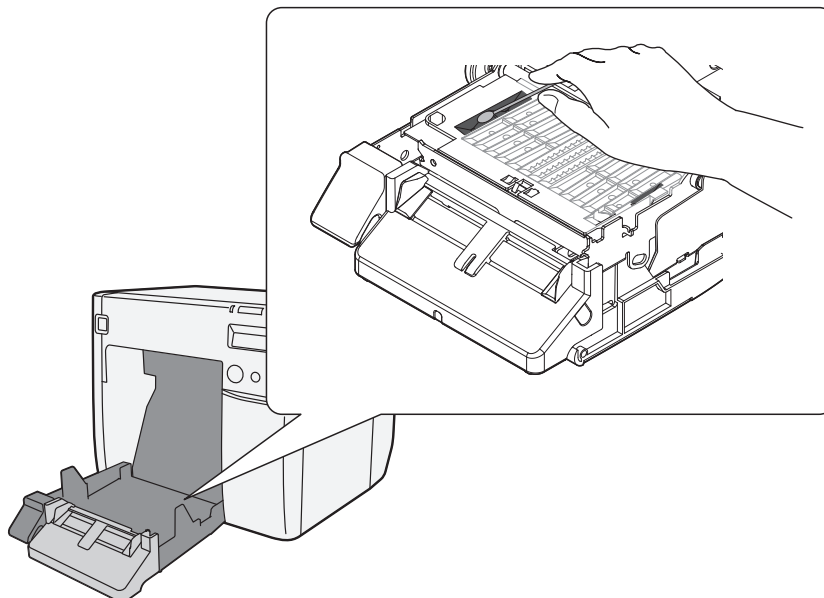

- 6 Close the roll paper cover.

Cleaning the Autocutter

Adhesive from labels may stick to the fixed blade of the autocutter, which may prevent the autocutter from cutting paper cleanly. If this happens, follow the steps below to clean the autocutter.

- 1** Turn off the printer, and unplug the AC cable from the outlet.
- 2** Open the roll paper cover and remove the paper.
- 3** Remove the adhesive on the autocutter blade on the side of the roll paper cover with an implement such as a cotton swab.
If necessary, moisten the cotton swab with alcohol.

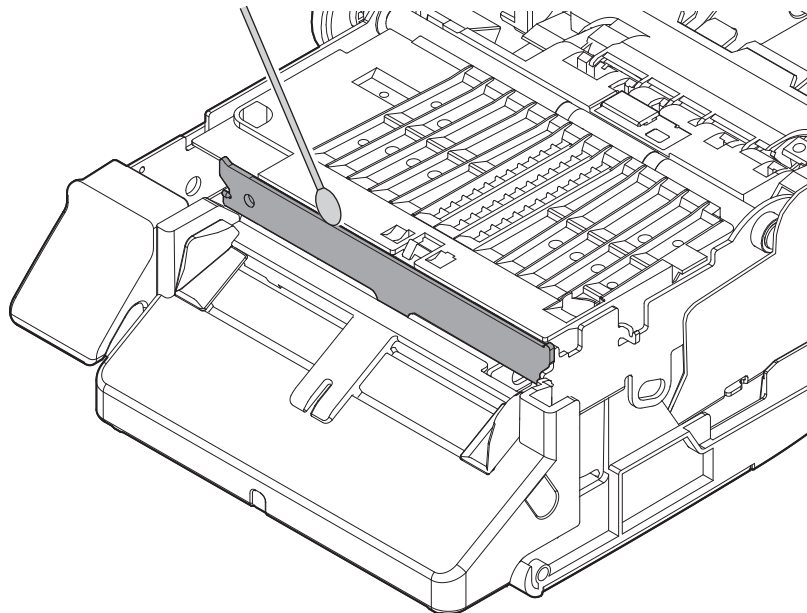

Do not touch the fixed blade of the autocutter directly. Doing so may cause injury.

Media arrangement

Media arrangement when feeding media for printing from the first sheet

Roll paper

This can be used with the following media forms.

- Continuous paper (Blackmark)
- Die-cut label (Blackmark)
- Die-cut label (Gap)
- Transparent die-cut label

Loading Paper

When feeding paper, bring the edge of the roll paper between the autcutting position and the edge of the paper ejection table, then close the roll paper cover.

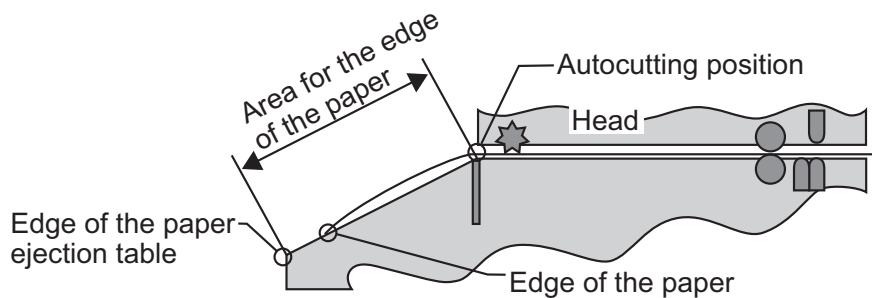

Method for arranging the media

- Continuous paper (Blackmark)
Place the edge of the first black mark in a position 172.5 mm {6.791"} or more from the edge of the roll paper, and do not place a black mark before there.

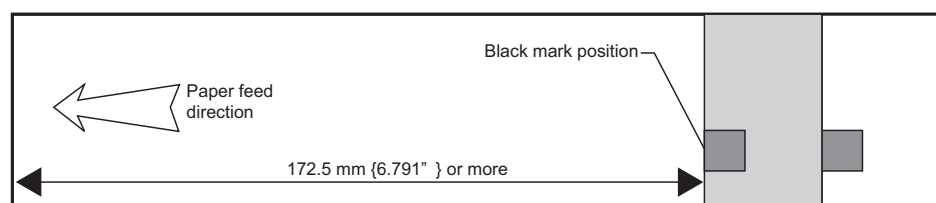

- Die-cut label (Blackmark), die-cut label (gap), and transparent die-cut label
Place the edge of the first label in a position 172.5 mm {6.791"} or more from the edge of the roll paper, and do not place a label or black mark before there, leaving only the backing.

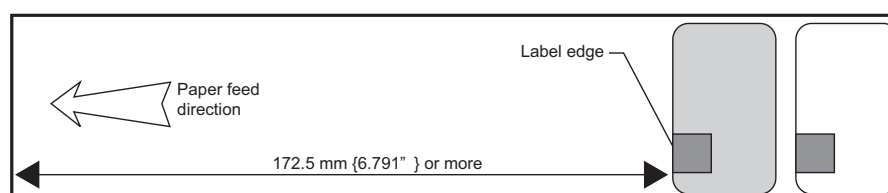

Fanfold Paper

The following media is supported:

- Continuous paper (Blackmark)
- Die-cut label (Blackmark)

Method for arranging the media

- Continuous paper (Blackmark)

Place the edge of the first black mark in a position 25 mm {0.98"} or more from the edge of the paper, and do not place a black mark before there.

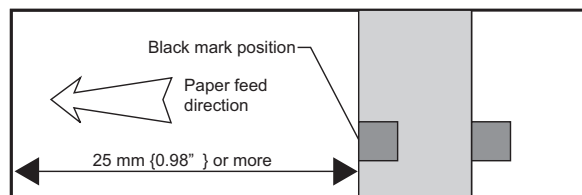

- Die-cut label (Blackmark)

Place the edge of the first label in a position 25 mm {0.98"} or more from the edge of the paper, and do not place a label or black mark before there, leaving only the backing.

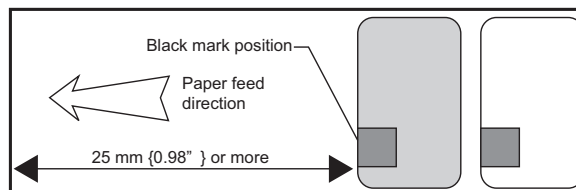

Media arrangement for printing on the last sheet

Roll paper

The following media is supported:

- Continuous paper (Blackmark)
- Die-cut label (Blackmark)
- Die-cut label (Gap)
- Transparent die-cut label

Premise

- The starting part of the paper roll and the roll core are not glued or taped down.
- “No autocut: feed to peel off position” is not selected at “Settings for paper handling after print”.
- For Continuous paper (Blackmark) and Die-cut label (Blackmark), Enable “Notification setting at media size error”.

Go to [Printer Utilities] - [Printer Preferences] - [Advanced Settings] - [Notification Settings], then from the [Notification Setting at a Media Size Error] menu, select [Notify errors].

Method for arranging the media

- Continuous paper (Blackmark), and Die-cut label (Blackmark)

Ensure a margin of 107.5 mm {4.32"} or more from the rear edge of the last ticket or label to be printed, and for labels, leave only the backing. Also, behind the last ticket or label to be printed, place a black mark [A in the figure] at the same interval up until that point [L in the figure], leave a gap of 5 ± 0.5 mm { 0.20 ± 0.02 } behind that, and place another black mark [B in the figure]. The maximum interval between the aforementioned 2 black marks is 11 mm {0.43"}.

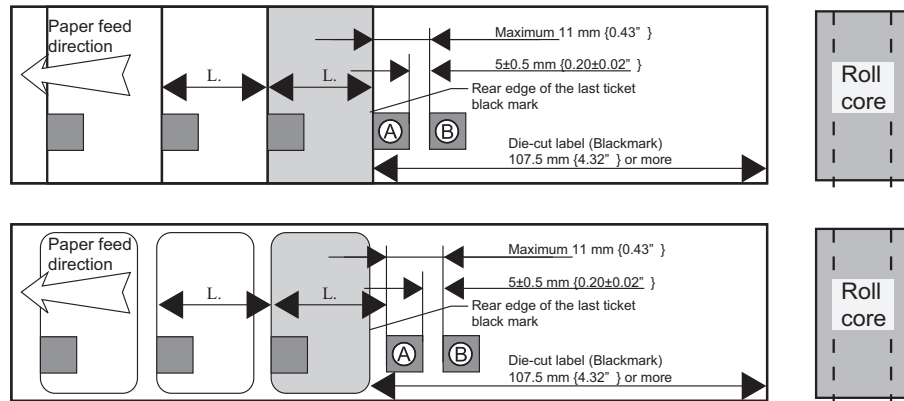

CAUTION

Once the printing processing (including autcutting) for the last ticket or label is completed properly, directly after the new print data is sent to the printer, a "Media size error" occurs, and the printer stops with the print data saved.

- Die-cut label (Gap), and transparent die-cut label

Leave only the backing for 107.5 mm {4.32"} or more after the rear edge for the last label to be printed, and do not place a label there.

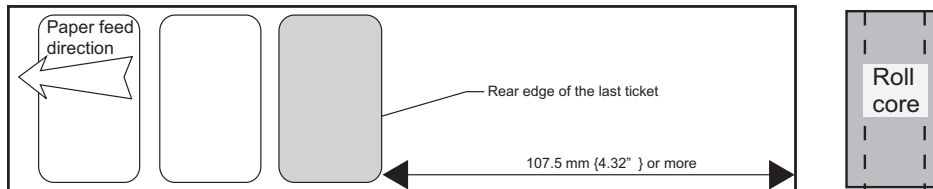

CAUTION

Once the printing processing (including autcutting) for the last ticket or label is completed properly, directly after the new print data is sent to the printer, a "Media size error" occurs, and the printer stops with the print data saved.

Fanfold paper

The following media is supported:

- Continuous paper (Blackmark)
- Die-cut label (Blackmark)

Premise

- Moving to the peel position as post-printing processing is not selected.
- For Continuous paper (Blackmark) and Die-cut label (Blackmark), Enable "Notification setting at media size error".

Go to [Printer Utilities] - [Printer Preferences] - [Advanced Settings] - [Notification Settings], then from the [Notification Setting at a Media Size Error] menu, select [Notify errors].

Method for arranging the media

Ensure a margin of 107.5 mm {4.32"} or more from the rear edge of the last ticket or label to be printed, and for labels, leave only the backing. Also, behind the last ticket or label to be printed, place a black mark [A in the figure] at the same interval up until that point [L in the figure], leave a gap of 5 ± 0.5 mm { 0.20 ± 0.02 " } mm behind that, and place another black mark [B in the figure]. The maximum interval between the aforementioned 2 black marks is 11 mm {0.43"}.

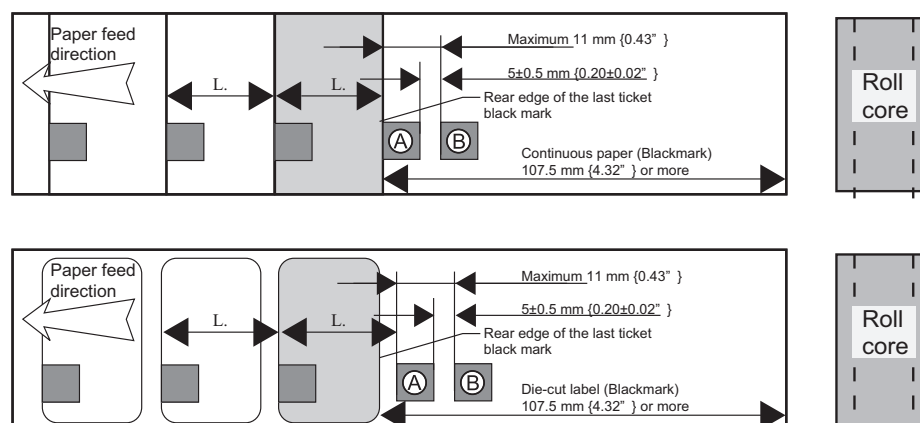

CAUTION

Once the printing processing (including autocutting) for the last ticket or label is completed properly, directly after the new print data is sent to the printer, a "Media size error" occurs, and the printer stops with the print data saved.

Setting the label size and paper layout for borderless printing

This section explains the approaches for borderless printing and how to set the paper size and layout.

Apply the settings when designing the label paper, making the driver settings, and setting the data size on the application.

Requirement

- To perform borderless printing, set the print area bigger than the actual label size by 1.5 mm on all sides.
- Select [Borderless Printing].
- Labels are half-cut, and fringes are not removed except for the left and right edges.
- The positions of the labels are detected by black marks as there are no gaps between labels.
- Select [Continuous Paper (BlackMark)] for Media Form.
- Set and print black marks at 1.5 mm above the tip of the label on back side.
- The example shows the label paper with one label placed sideways along the paper width.





Setting example

- Label size
Width: 60.0 mm
Length: 35.0 mm
- Printer driver's [User Defined Media Layout] settings
Media Form: Continuous Paper (BlackMark)
Borderless Printing: Check
Media Width: 63.0 mm
BlackMark Interval: 38.0 mm

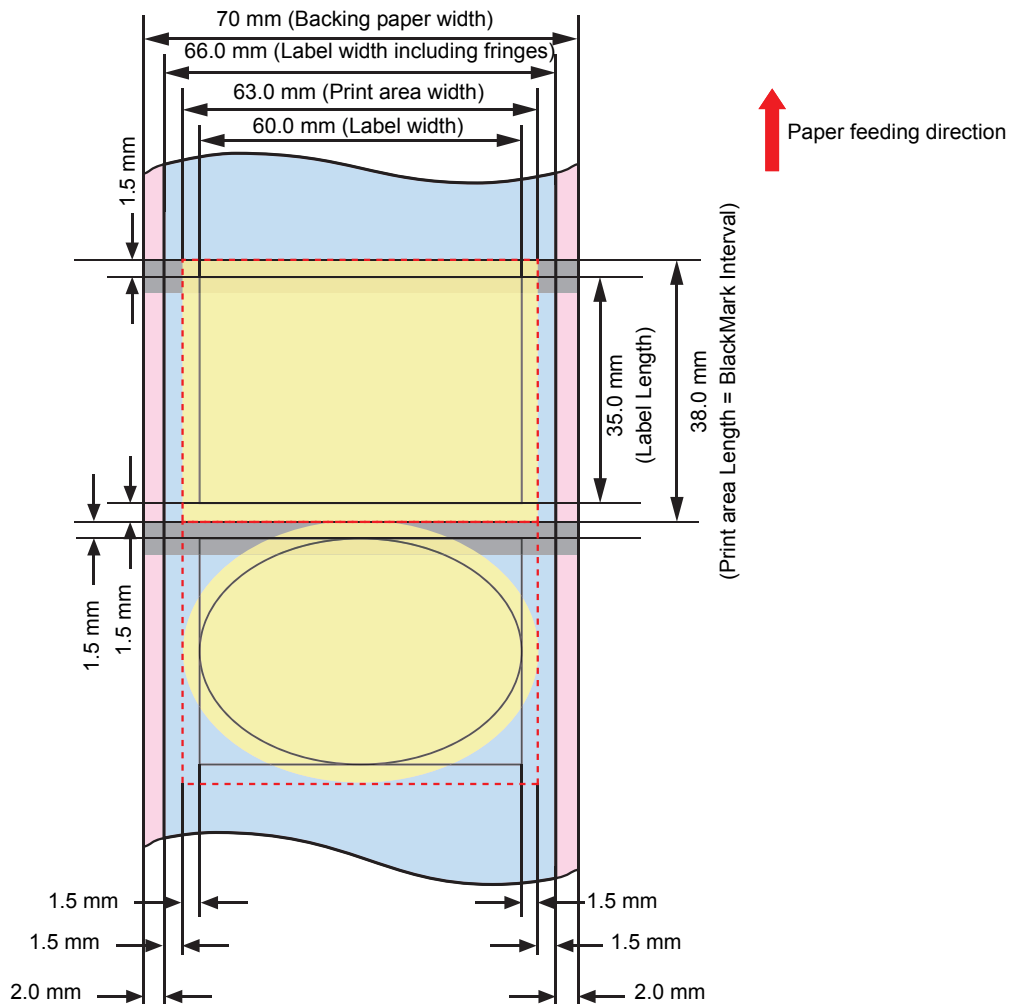
NOTE

- Use the same approaches when creating label other than square-shaped.
- Depending on the label shape, the label may peel off from the backing paper inside the printer. Check the label thoroughly before use.



-  Print area specified in [User Defined Media Layout] in the printer driver
-  Printing data position
(Top: 63.0 × 38.0 mm rectangular/Bottom: 63.0 × 38.0 mm oval)
-  Label area
-  Backing paper
-  Black mark position

How to Make Media Settings

Depending on the paper you are using, the print result may be faint or white lines or black lines may be printed. Follow the steps below to make paper settings.

- 1** Load the paper and turn on the printer.
- 2** Display the printer driver window.
(For details on how to display the printer driver window, see ["Setting the Printer Driver" on page 50.](#))
- 3** From the printer driver's (General) tab, select (Printing Settings) - (Media Type) to select the recommended setting.

NOTE

Contact your dealer for the recommended settings.

When the recommended value for [BkCMY (Ink Profile)] and [Bk (Ink Profile)] is not 0, make settings in [Ink Profile/Brightness Adjustment] on the printer driver's [Advanced] screen.
For details, see ["Banding Reduction" on page 50.](#)

- 4** Open the (Printer Utilities) tab, and then click (Printer Setting Utility).
- 5** Click (Printer Adjustment) - (Print Head Alignment) - (Bi-direction Printing Adjustment) - (Start Adjustment) to adjust the paper feeding amount.
For details, see ["Print Head Alignment" on page 136.](#)

Application Development Information

This chapter describes how to control the printer and gives information useful for printer application development.

Printer Control Method

The control method for the printer differs depending on the use environment.

| Application specifications | Control method | Page |
|--|------------------------------------|--------------------------|
| Printing using the Epson printer driver installed during the setup operation in chapter 2. | Use an Epson printer driver | page 31 |
| Printing using the application developed from EPSON Inkjet Label Printer SDK. | Use EPSON Inkjet Label Printer SDK | page 174 |

Printer Driver

The printer driver has the following functions and these are not necessary to implement in the application.

- ❑ Barcode and 2D symbol font is implemented. The barcode and 2D symbol font can also be printed using font replacement function for .NET environment.

The barcode and 2D symbol font must be set in advance on the printer driver to use this function. (See "[Barcode Printing](#)" on page 89 and "[2D Symbol Font Settings](#)" on page 101 for details of how to make setting.)

On .NET environment, True Type font is specified to be replaced by barcode and 2D symbol font. The barcode and 2D symbol can be printed by specifying replaced True Type font from the application. (See "[Barcode and 2D Symbol Font Printing on .NET Environment](#)" on page 108 for details about font replacement function.)

Using Epson Inkjet Label Printer SDK

The necessary environments to print with a customer's application using an Epson's printer driver are provided as SDK. The following items are included.

| Items | Description |
|---|---|
| EPSON Inkjet Label Printer SDK User's Guide | This explains the configuration overview of the Inkjet Label Printer SDK, necessary functions to control Epson Inkjet label printers from an application, and settings that need to be performed in a printer driver in advance. |
| EPDI (EPSON Printer Driver Interface) | The EPDI (EPSON Printer Driver Interface) provides the application-programming interface for the Epson's printer driver. By using the EPDI, the Epson's printer driver settings can be performed from application software the customer is developing. For explanation of the EPDI and required technical information to use in an application program, refer to the "EPDI for Inkjet Label Printer Reference Manual" that comes with the SDK. |
| EpsonNet SDK | The EpsonNet SDK provides an API to acquire the status of the Epson inkjet label printer. For explanations of the API and required technical information to use in an application program, refer to "Reference for TM-C3500" that comes with the SDK. |
| Label Print Sample Program | Execution files of the application and source files of the program are provided, in which printing is performed from Epson inkjet label printers using the Inkjet Label Printer SDK. For how to use the sample program, refer to "Inkjet Label Printer SDK User's Guide". |

Operating environment

| | |
|----------|--|
| OS | Refer to Appendix |
| Software | A printer driver (installed using the Install Navi). .NET Framework Ver.3.5 (It is not provided by Epson, customers should prepare a printer driver). |

Where to download

Download it from Epson website.

Utilities and Manuals

The several kinds of utilities and manuals other than the printer driver are available for this printer.

| Name | Manual |
|---------------------------------------|---|
| Printer Driver | TM-C3500 Series Technical Reference Guide |
| EPSON Inkjet Label Printer SDK | EPSON Inkjet Label Printer SDK User's Guide |
| InstallNavi | None |
| EpsonNet Config | EpsonNet Config Manual |
| USB Printer class Replacement Service | None |
| EPSON Deployment Tool | EPSON Deployment Tool User's Manual |
| EPSON Monitoring Tool | EPSON Monitoring Tool User's Manual |
| EpsonNet SetupManager | None |

Install Navi

This utility is used to install the printer driver and set up the printer.

Following the instructions on the screen, you can install the printer driver and set up the printer at the same time.

EpsonNet Config

The network setting and changes are available for more than one Epson printers in the network.



Some Epson printers are not supported.

USB Printer Class Device Replacement Service

This is a resident service on the computer. When the TM-C3500 is replaced for service or other reason, this detects the printer connection and automatically changes the output printer of the printer driver.

This allows the printer to be replaced without changing settings in the application. (The printer is not replaced if a port is specified for the application output destination. The printer is only replaced if the printer driver is specified.)

There is no need to change the USB serial number of the TM-C3500 before replacement.

Uninstallation of USB Printer Class Device Replacement Service

USB Printer Class Device Replacement Service is not displayed in the software list in the control panel. For uninstallation, follow the steps below.

- 1 Close all applications running on the computer.
- 2 Select (Start) - (Control Panel) - (Uninstall a program) - (EPSON Printer Driver Utility). Click (Uninstall/Change).
- 3 "EPSON Printer Utility Uninstall" screen appears. Select (Utility) tab.

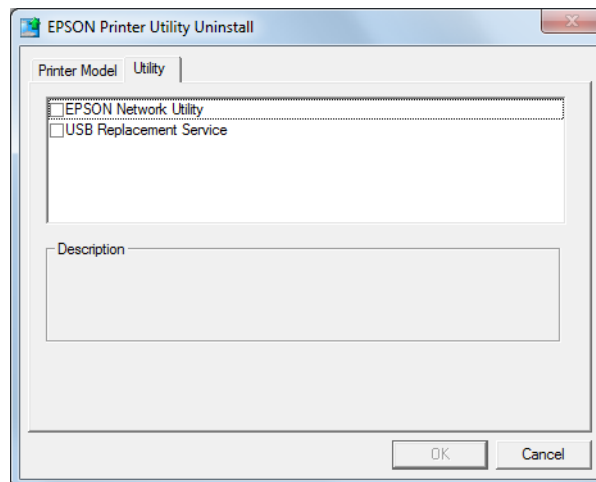

- 4 Select (USB Replacement Service) and click (OK).
Click [OK] to start uninstallation.
- 5 The completion window appears. Click (OK).

Restrictions in USB Printer Class Device Replacement Service

After the printer is replaced, the green check mark indicating [default printer] in "Devices and Printers" window may be shown on the previous printer that was applied before replacement. Or the check mark may not appear. In these cases, the check mark indication can be corrected with the following steps:

- Return to the desktop screen and open "Devices and Printers" window again.
- Right-click the printer driver and select [Set as default printer].
- Log off the user account and restart the operating system.

EPSON Deployment Tool

This is the utility to support kitting operations for multiple printers and client computers. The following functions are available:

- The user can set up the following items at a time before ink charging.
 - Network settings such as IP address
 - Media source settings
 - Media detection settings
- The user can create a package to simultaneously install and set up the printer driver to a client computer.
- The user can create a package integrating the driver setting change of multiple printers. To apply this package to a network printer, use EPSON Monitoring Tool.

CAUTION

Use this utility in an environment where TM-C3500 Printer Driver and EpsonNet SetupManager are installed.

NOTE

For details on how to use the utility, see EPSON Deployment Tool User's Manual.

EPSON Monitoring Tool

This is the utility to monitor the status of the printer connected to the network and to change the printer settings. This utility is used with EPSON Deployment Tool to support kitting operations for the printer.

NOTE

For details on how to use the utility, see EPSON Monitoring Tool User's Manual.

EpsonNet SetupManager

This is the utility to create a package to automatically install the printer driver and various types of application and set up the printer driver. This utility is also used for EPSON Deployment Tool.

NOTE

For details on how to use the utility, see the help for EpsonNet SetupManager.

Download

Drivers, utilities, and manuals can be downloaded from one of the following URLs.

For customers in North America, go to the following web site:

<http://www.epsonexpert.com/> and follow the on-screen instructions.

For customers in other countries, go to the following web site:

<https://download.epson-biz.com/?service=pos>

Maintenance

This chapter describes the efficient management method of the printers and printer drivers by using utilities, targeted at the system administrators operating multiple TM-C3500 units and client computers.

- Setting up printer before installation (media type, IP address)

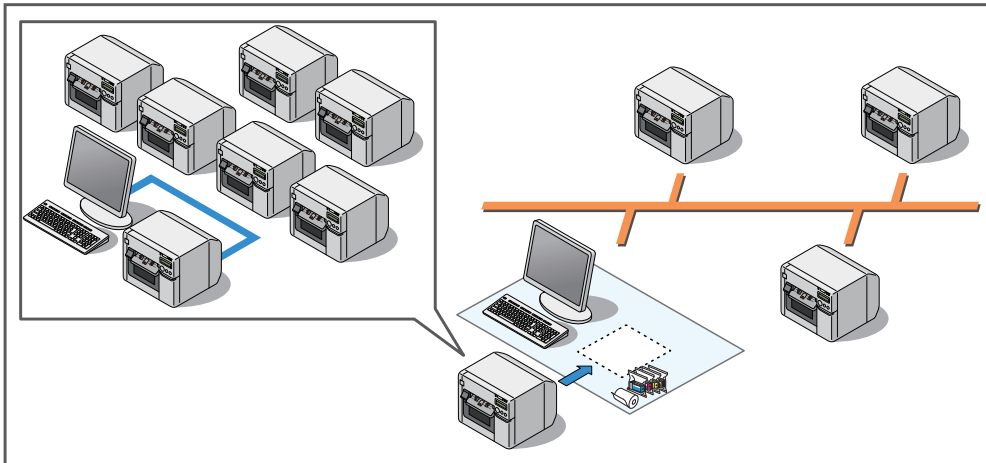

- Changing the printer settings from the administrator's computer

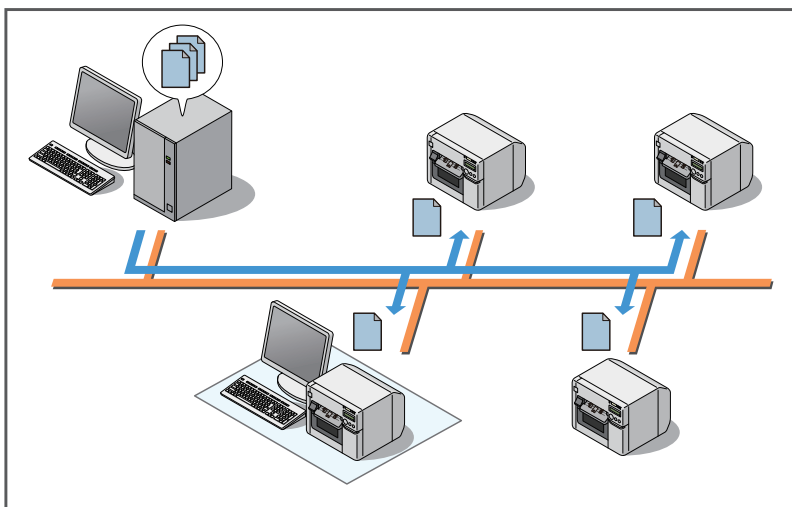

* For local printers, distribute the backup file and set up a printer from the client computer.

- Creating a package to install/set up the printer driver on a client computer.
The printer driver setup can be completed only by executing from each client computer.

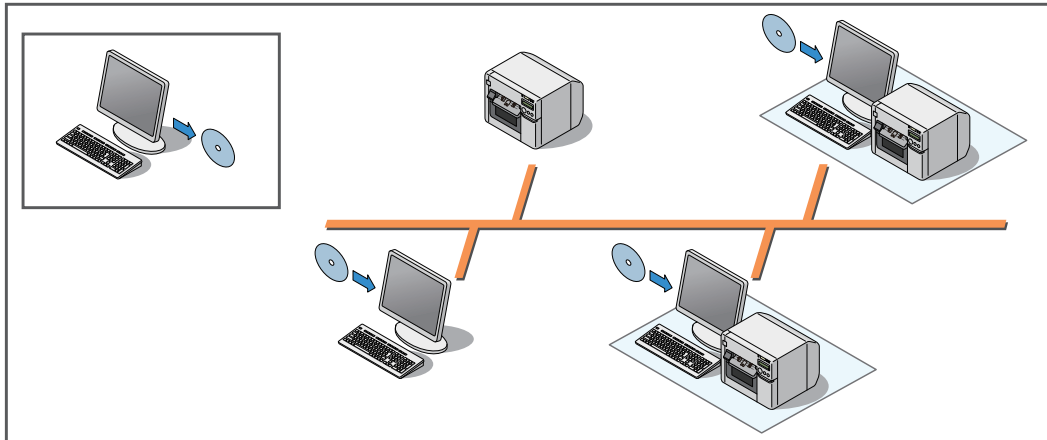

Necessary information for an administrator of the printer ([page 181](#))

- Utility ([page 181](#))
- Setting the Printer ([page 182](#))
- Setting the Printer Driver ([page 183](#))

System Configuration ([page 185](#))

- Installing the Printer ([page 185](#))
- Distributing the Printer Driver ([page 186](#))

Maintenance ([page 187](#))

- Changing the Printer Settings ([page 187](#))
- Changing the Printer Driver Settings ([page 192](#))
- Monitoring the Network Printer ([page 193](#))
- Replacing the Printer ([page 194](#))

Necessary Information for an Administrator of the Printer

This section describes the necessary information particularly for the administrator of the printer.

Utility

The utilities are provided to set up multiple printers and client computers.

| Setting | During system configuration | During maintenance |
|------------------------|--|-----------------------|
| Printer setting | EPSON Deployment Tool | EPSON Monitoring Tool |
| Printer driver setting | <ul style="list-style-type: none"> • EPSON Deployment Tool • EpsonNet SetupManager | EPSON Deployment Tool |

NOTE

- For details on EPSON Monitoring Tool, see EPSON Monitoring Tool User's Manual.
- For details on EPSON Deployment Tool, see EPSON Deployment Tool User's Manual.
- Using EPSON Deployment Tool to change the printer driver settings allows integration of the settings of multiple settings for each client computer or printer queue into a package. For each setting, you can specify the executing computer name and the printer queue. Then, executing this package on each client computer can apply only the necessary settings.

Setting the Printer

You can set the following items before charging ink in the printer:

- Media source settings
- Media detection settings
- Network settings such as IP address

You can set the media settings and IP address settings which are minimally necessary to use a printer before ink charging. This reduces operations at the installation location, contributing to reduction in required time and efficiency improvement for installation operation.

You can also avoid troubles caused by moving the printer after ink charging.

<Administrator's Computer>

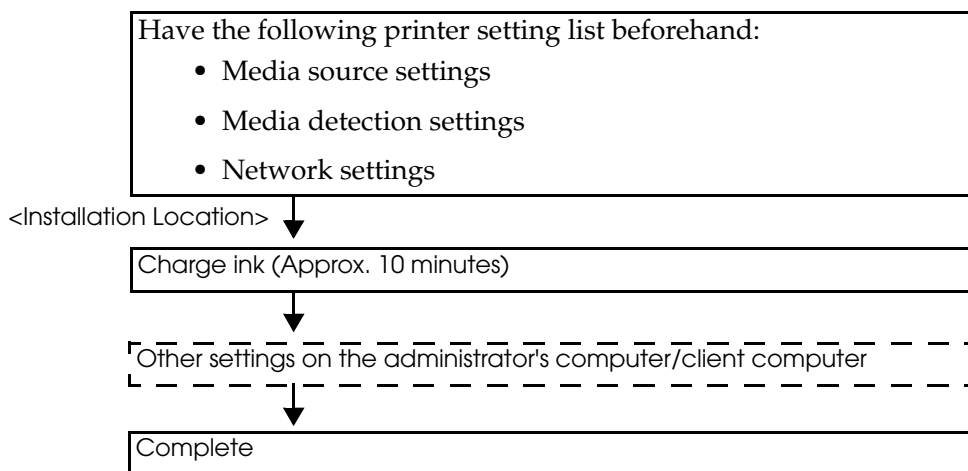

Setup after ink charging

Set the items listed below after ink charging. For details on the settings after ink charging, see ["Changing the Printer Settings" on page 187](#).

- Printer operation settings
- Notification settings
- Panel button settings
- Operating time settings
- Paper feed adjustment

| Printer | Setting procedure |
|-----------------|---|
| Local Printer | Using TM-C3500 Printer Driver on each client computer |
| Network Printer | Using EPSON Monitoring Tool |

Setting the Printer Driver

The printer driver settings can be output to a configuration file (*.bsf) or imported from another configuration file. When using such operations, note the following point:

NOTE

The BSF file is used also when creating a package (driver installation package/driver setting change package) for client computer setup.

- ❑ Register "Current Settings" of the printer driver to [Favorite Setting] before saving to a BSF file. If not registered to [Favorite Setting], the printer driver settings cannot be saved to the BSF file.
- ❑ The setting items shown below are used as common items when multiple printer queues are created in a computer. When a BSF file is imported, the settings are overwritten. Therefore, to retain the existing settings, create a BSF file including the existing settings.

• Favorite List

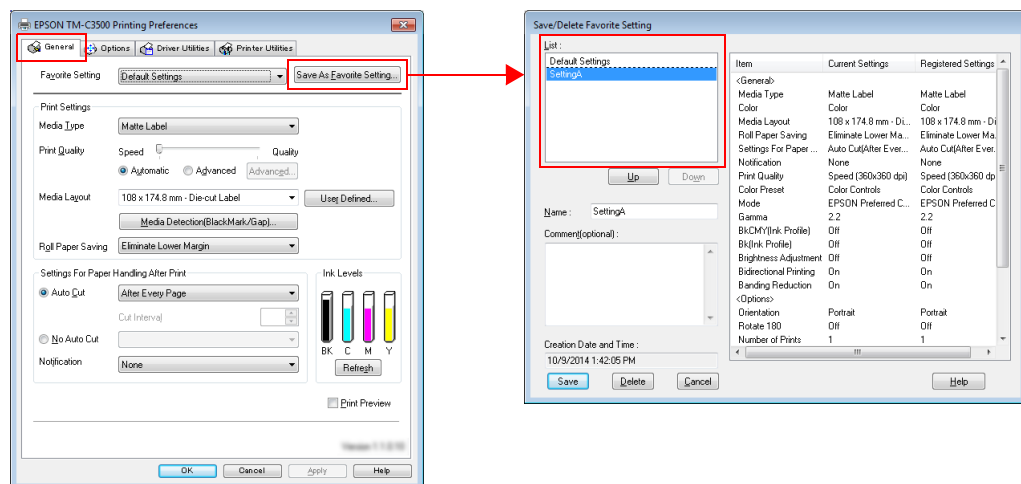

• User Defined Media List

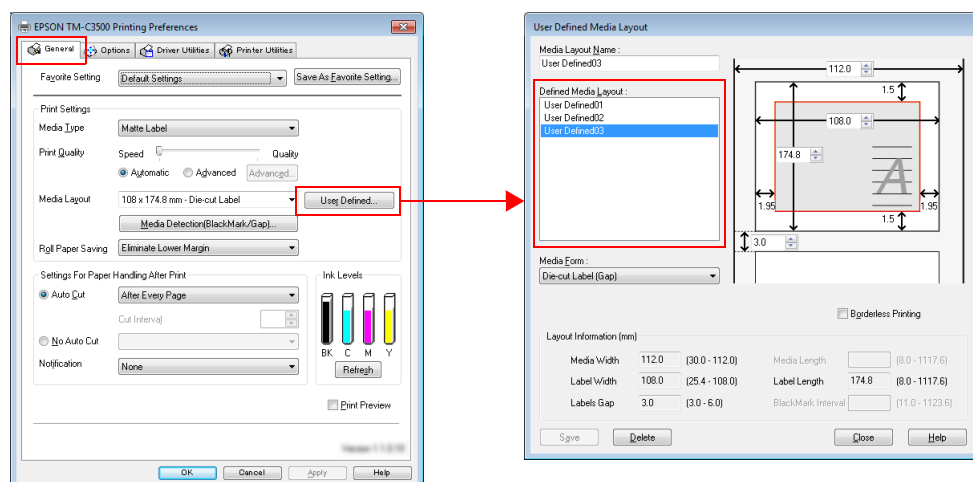

- Barcode Font List

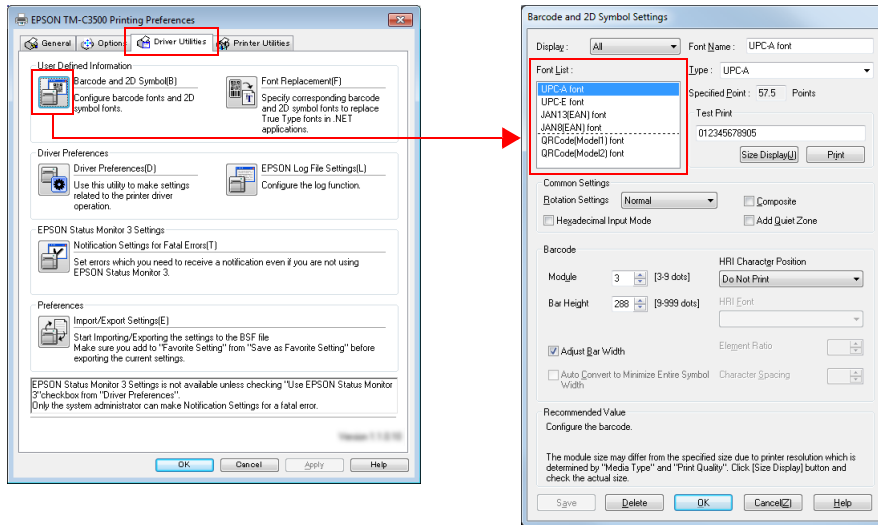

- Barcode Font Replacement List

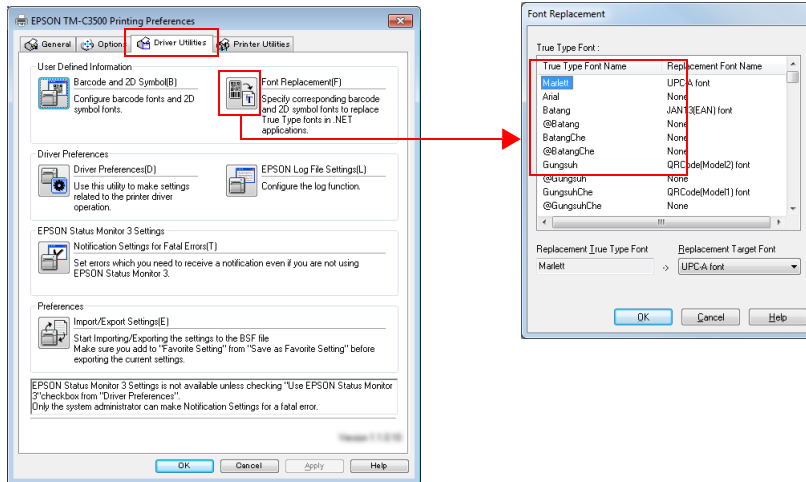

System Configuration

Installing the Printer

Set up a printer using Epson Printer Deployment of EPSON Deployment Tool and install the printer in the specified location.

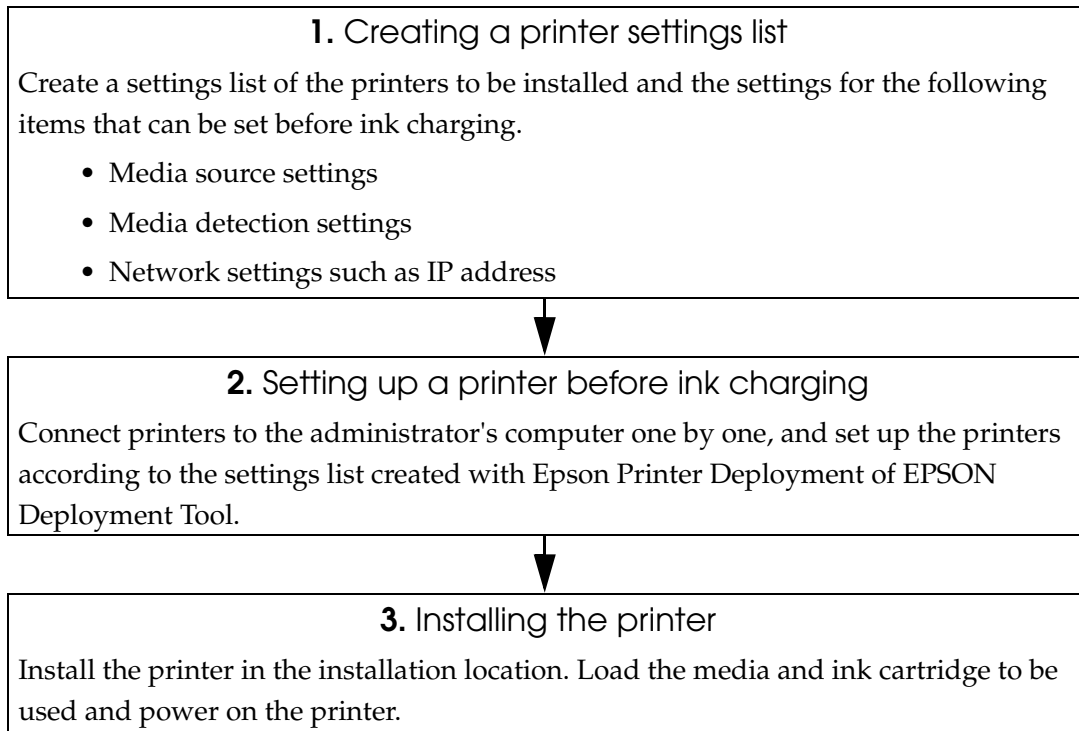
**CAUTION**

Install the following items to the administrator's computer in advance:

- * TM-C3500 Printer Driver
- * EPSON Deployment Tool

NOTE

For details on the printer setting procedure, see EPSON Deployment Tool User's Manual.

Distributing the Printer Driver

Create a driver installation package and distribute it to each client computer.

The driver installation package is used to automatically install the printer driver and set up the printer driver. The package is created using Epson Driver Deployment of EPSON Deployment Tool and EpsonNet SetupManager. Follow the steps below to create the package.

1. Creating a BSF file

Start TM-C3500 Printer Driver on the administrator's computer and create a BSF file for the environment of all client computers. For details on how to create a BSF file, see ["Exporting/Importing Printer Driver Settings" on page 87](#).



2. Creating a driver setting change package

Start Epson Driver Deployment on the administrator's computer and create a driver setting change package. The driver setting change package is a package integrating the settings in an environment where each client computer has different printer driver settings or where multiple printer queues are set in a client computer. You do not have to create this package when using the same network printer or using a local printer with the same settings.



3. Creating a driver installation package

Start Epson Driver Deployment on the administrator's computer and create a driver installation package.



4. Configuring environment of a client computer

Distribute the driver installation package created in the administrator's computer to each client computer and execute the package. Installation of the printer driver automatically starts and the settings are automatically configured in accordance with the client computer environment.

CAUTION

Install the following items to the administrator's computer in advance:

- * TM-C3500 Printer Driver
- * EPSON Deployment Tool
- * EpsonNet SetupManager

NOTE

For details on how to create a driver installation package, see EPSON Deployment Tool User's Manual.

Maintenance

Changing the Printer Settings

Follow the steps below to change the printer settings, for example, to change the media type:

Network Printer

To change the settings for network printers, use EPSON Monitoring Tool provided for administration.

To change the settings for multiple printers at a time, create a backup file in advance and change the settings using EPSON Monitoring Tool. For details on how to create a backup file, see "[Creating a Printer Backup File](#)" on page 189.

CAUTION

Before using EPSON Monitoring Tool, register the network printers. Printers on the same network are automatically registered. For a network printer on an external network, register the IP address of the printer to EPSON Monitoring Tool before using it.

NOTE

- Install the following items to the administrator's computer in advance:
 - * TM-C3500 Printer Driver
 - * EPSON Monitoring Tool
- For details on how to change the settings for network printers, see EPSON Monitoring Tool User's Manual.
- When the media settings are changed, the printer driver settings must also be changed. For details, see "[Changing the Printer Driver Settings](#)" on page 192.

Local Printer

To change the settings for local printers, use TM-C3500 Printer Driver.

Follow the steps below to change the settings:

- 1 Prepare a backup file and distribute it to the client computer.
For details, see ["Creating a Printer Backup File" on page 189](#).
- 2 Connect the client computer to the printer whose settings are to be changed.
- 3 From the TM-C3500 printer driver, start TM-C3500 PrinterSetting.
- 4 Click (Settings Save and Restore).
- 5 Click (Restore Settings).

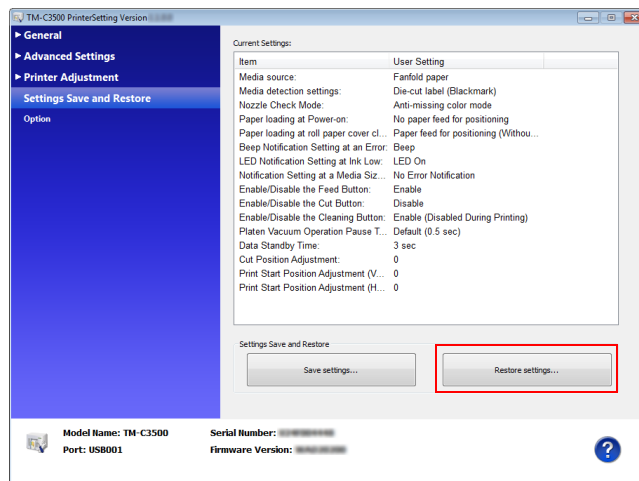

- 6 The "Open" window appears. Specify the backup file prepared in Step 1.

- 7 The following window appears. Click (Yes).

The setting process starts.

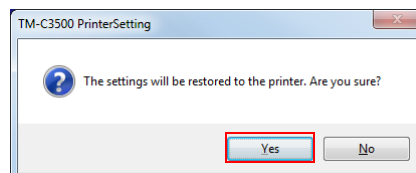

- 8 When the process is completed, the following window appears. Click (OK) and power on the printer again.

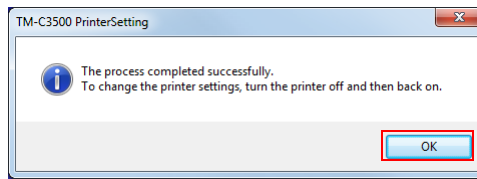
**NOTE**

When the media settings are changed, the printer driver settings must also be changed. For details, see ["Changing the Printer Driver Settings" on page 192](#).

Creating a Printer Backup File

After ink charging, create a backup file containing the printer settings to set up a printer. The backup file can be created from TM-C3500 Printer Driver.

You do not have to create this file when the settings other than the media type and IP address are unnecessary.

NOTE

The backup file must be created on the administrator's computer. Install TM-C3500 Printer Driver to the administrator's computer before starting the operation.

The settings to be saved in a backup file

- Media settings
- Printer operation settings
- Notification settings
- Panel button settings
- Operating time settings
- Paper feed adjustment

Backup file creation procedure

Follow the steps below to create a backup file.

- 1 Start TM-C3500 Printer Driver.
- 2 Select (Printer Utilities) and click (Printer Setting Utility).

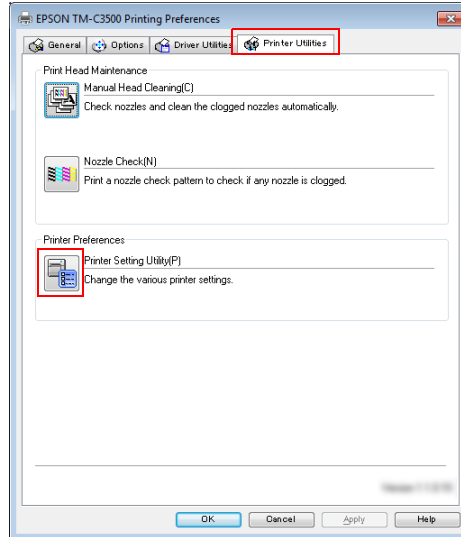

- 3 TM-C3500 PrinterSetting starts. Specify the printer settings.
- 4 Click (Settings Save and Restore).

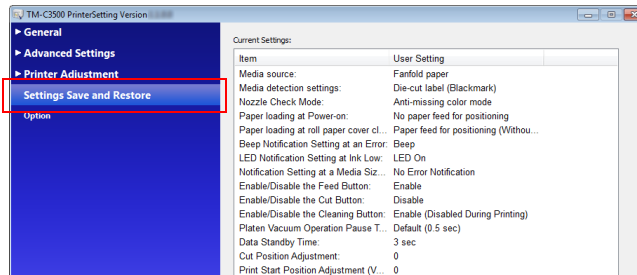

- 5 Confirm (Current Settings) and click (Save Settings).

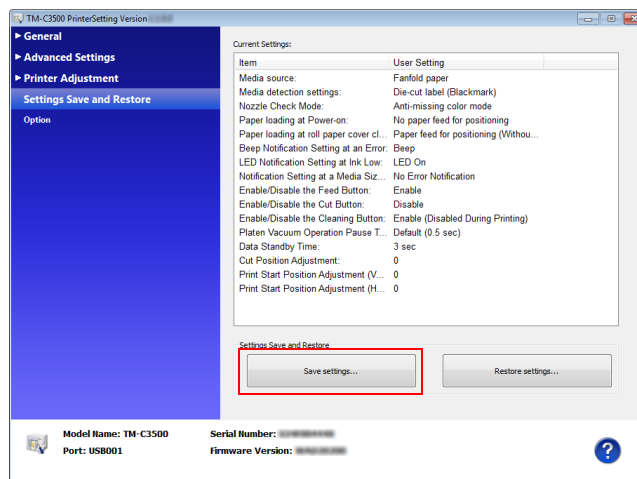

- 6 "The Save As" window appears. Specify a name and save the backup file.
- 7 The following window appears. Click (Yes).

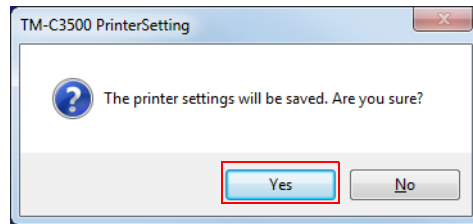

- 8 The process completion window appears. Click (OK).

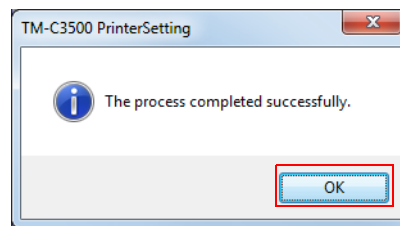

Changing the Printer Driver Settings

To change the settings of the printer driver being used, for example, to add the user defined media, create a driver setting change package using Epson Driver Deployment of EPSON Deployment Tool and execute it on a client computer.

The driver setting change package is a package integrating the settings in an environment where each client computer has different printer driver settings or where multiple printer drivers are installed in a client computer.

CAUTION

Before creating a driver setting change package, create a BSF file for each printer queue.

- * To add the user defined media and barcode/2D symbol, create a BSF file including the existing settings.
- * When multiple printer queues are registered in a client computer, create a BSF file including the existing settings of all printer queues.

NOTE

For details on how to create a driver setting change package, see EPSON Deployment Tool User's Manual.

Monitoring the Network Printer

The EPSON Monitoring Tool is an application for managing the network printer. You can monitor the status of the network printer from the administrator's computer with this.

NOTE

For details, see the EPSON Monitoring Tool User's Manual.

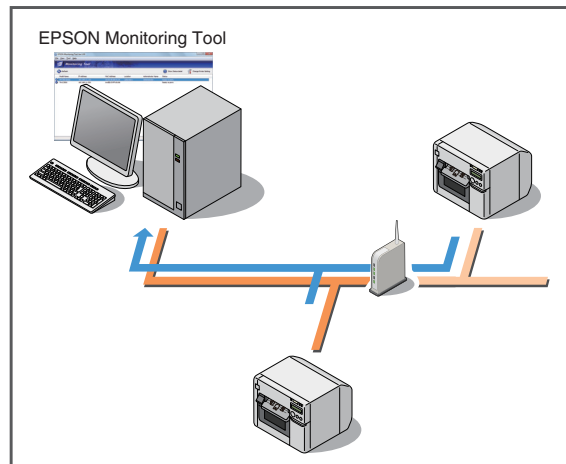

Acquirable information

- Model name/IP address/Location/MAC address/Administrator name/Status details is included in the information.
- Information of network printers other than the TM-C3500 can also be acquired. However, the information may be impossible to acquire or limited depending on the printer model.

Replacing the Printer

If the printer needs replacement because of a failure or other reason, it cannot be used by simply replacing the printers. This explains the methods for replacing the printer without changing the application on the client computer.

Local Printer

Replace the printer using the USB Replacement Service.

The USB Replacement Service is a program that detects when a new printer is connected, changes the properties information of the printer driver registered in Windows, and automatically changes the output port. When this is installed as a resident program on the client computer, it is not necessary to configure settings in the application, printer driver, or OS. However, printer settings are required.

❑ Preparation

- Install the USB Replacement Service on the client computer.
- Backup file of the existing printer

❑ Printer replacement procedure

1. Start Deployment Tool on the administrator's computer and set the Media source settings and Media detection settings to the new printer.
2. Remove the existing printer from the client computer. Connect the new printer and power on the printer. The USB Replacement Service will detect the connection of the new printer and set a new printer port for the existing printer driver.
3. Set the media and ink cartridge in the new printer and charge ink.
4. Set up the new printer with the existing printer settings using the backup file of the existing printer.

Network Printer

Configure the IP address and other network settings of the existing printer and the settings of the existing printer in the new printer. There is no need to configure the printer driver on the client computer.

□ Preparation

- The network setting information of the existing printer (IP address and so on)
Print the status sheet with the existing printer. (See "[Status Sheet Printing \(LAN interface model only\)](#)" on page 161)
- Backup file of the existing printer

□ Printer replacement procedure

1. Start Deployment Tool on the administrator's computer and set the IP address, Media source settings, and Media detection settings to the new printer.
2. Install the new printer in the location where the existing printer was installed and connect it to the network.
3. Set the media and ink cartridge in the new printer and charge ink.
4. From EPSON Monitoring Tool on the administrator's computer, set up the printer using the backup file.

For Inquiries

If you have any technical questions about this printer, or if any problems occur, please contact us with the following information.

NOTE

- Contents of technical questions must be about our printers only. For those about products of Microsoft Corporation or other companies, please contact them.
- If any problems occur, check whether there is any physical cause (such as connection or power problems) before contacting us.

- Type of inquiry: Problem / Question
- Date:
- Your company:
- Department:
- Your name:
- Phone/Fax/Email:
- Computer information:
 - Manufacturer / CPU
- OS (with Service Pack information):
- Model name of the printer:
- Printer driver: Installed / Not installed
- Connection type: USB / LAN / MS shared (Client / Server)
- Install protocol/service: NetBEUI / NetWare Client (Novell (Ver.)) / Microsoft (Ver.))
/ TCPIP / SNMP agent / Other
- Print tool: Local (USB) / Standard TCPIP / OS attached LPR
/ Epson TCPIP Print (Name) / Own custom application
/ Other (Product name/Ver.)
- Firewall: OS standard / Personal (Product name/Ver.) / None
- Your application information:
 - Windows service operation / Normal EXE operation
- Epson application status: EPSON Monitoring Tool/ EpsonNet SDK for Windows
/ Printer Setting Utility / Other (Application name)
- Phenomenon of the problem (or content of the question):
- System configuration: Hardware configuration such as computer and network, and Software
module configuration
- Procedure of reproduction of the problem: Operation procedure, functional procedure, function
and argument value to reproduce
- Reproducibility of the problem: Yes (out of times) / No

Appendix

Product Specifications

| | | |
|---|------------------------------------|---|
| Printing method | | Serial ink jet, dot matrix 4 color (KCMY) printing |
| Paper feed | | Forward and reverse friction feed |
| Autocutter | Cutting method | By separated-blade scissors |
| | Auto-cut type | Full cut (cuts paper completely) |
| Graphic resolution | | 360 dpi × 360 dpi, 720 dpi × 360 dpi |
| Print speed | | 103 mm/s (printing width 56 mm, 360 dpi × 360 dpi) 96 mm/s (printing width 72 mm, 360 dpi × 360 dpi) The print speed is different depending on the resolution and the printing width. |
| Paper (See "Paper Specifications" on page 199 for details) | Media type | Plain, Plain label, Matte, Matte label, Synthetic label, Wristband, Glossy label |
| | Media form | Continuous paper, Continuous paper (Blackmark), Full-page label, Transparent die-cut label, Die-cut label (Blackmark), Die-cut label (Gap) |
| | Media source | Roll paper, Fanfold paper |
| Ink cartridge (See "Ink Cartridge" on page 230 for details.) | | 4 color-ink separated exclusive ink cartridge |
| Interface | USB model | USB 2.0 high speed |
| | LAN model | LAN (100 Base-TX/10 Base-T) USB 2.0 high speed |
| Barcode/ two-dimensional symbol printing | Barcode | UPC-A, UPC-E, JAN 8 (EAN 8), JAN 13 (EAN 13), CODE39, ITF, Codabar, CODE93, CODE128, GS1-128, GS1 DataBar Omnidirectional, GS1 DataBar Truncated, GS1 DataBar Limited, GS1 DataBar Expanded |
| | Two-dimensional symbol printing | PDF417, QR code, Maxi Code, GS1 DataBar Stacked, GS1 DataBar Stacked Omnidirectional, GS1 DataBar Expanded Stacked, DataMatrix, Aztec |
| Power supply | | AC 100 to 240V (Dedicated AC adapter) |

| | | |
|--|----------|--|
| Temperatures/ humidity (See "Environmental Conditions" on page 232 for details.) | Printing | 10 to 35°C {50 to 95°F}, 20 to 80%RH (no condensation) |
| | Storage | When packed (ink not loaded): -20 to 60°C {-4 to 140°F}, 5 to 85%RH (no condensation) -20°C or 60°C {-4 to 140°F}: up to 120 hours Ink loaded: -20 to 40°C {-4 to 104°F} -20°C {-4°F}: up to 120 hours 0 to 30°C {32 to 86°F}: up to 6 months 40°C {104°F}: up to a month |
| Overall dimensions (W x D x H) | | 310 x 283 x 261 mm (excluding protrusions) {12.20 (W) x 11.14 (D) x 10.28" (H)} |
| Weight (mass) | | Approximately 12 kg {26.45 lb} (Not including the ink cartridge, maintenance box, AC adapter, and roll paper). |

Hardware Requirements

| | |
|----------|---|
| OS | Microsoft Windows 10 (32 bit/ 64 bit) Microsoft Windows 8.1 (32 bit/ 64 bit) Microsoft Windows 8 (32 bit/ 64 bit) Microsoft Windows 7 SP1 (32 bit/ 64 bit) Microsoft Windows Vista SP2 (32 bit/ 64 bit) Microsoft Windows XP SP3 (32 bit) Microsoft Windows XP SP2 (64 bit) Microsoft Windows Server 2012 R2 Microsoft Windows Server 2012 Microsoft Windows Server 2008 R2 SP1 Microsoft Windows Server 2008 SP2 (32 bit/ 64 bit) Microsoft Windows Server 2003 R2 SP2 (32 bit/ 64 bit) |
| Computer | Must support the following computers that run the above operating systems. • PC/AT compatible |
| CPU | Conforms to the operating environment of the OS |
| RAM | |
| HDD | |

CAUTION

The printers on the network is supported up to 64 printers. In that case, if the minimum requirements above are not met, the printer may not be able to come up to its standard.

Printing Specifications

| | | |
|----------------|--|--|
| Printable area | Roll paper | Minimum width 26 mm, Maximum width 104 mm |
| | Fanfold paper | Minimum width 46 mm, Maximum width 104 mm |
| Print speed | 360 × 360 dpi (horizontal × vertical) | Printing width 56 mm: 103 mm/s, 72 mm: 96 mm/s, 104 mm: 85 mm/s |
| | 720 × 360 dpi (horizontal × vertical) | Printing width 56 mm: 52 mm/s, 72 mm: 48 mm/s, 104 mm: 42 mm/s |

dpi : dots per 25.4 mm (dots per inch)

Paper Specifications

The following is the type and the size of paper specified for this printer.

CAUTION

- When using paper other than the specified, users must evaluate the recognition rate in advance to avoid deterioration of the paper feed accuracy/barcode recognition rate/print quality and frequent occurrence of paper jams.
- Depending on the temperature and humidity, the synthetic labels and paper backing have different ratios of expansion and contraction, and this causes the paper to curl. If the paper curls, the paper may be rubbed by the print head and become contaminated, or the paper may jam.
- Do not use the paper which is extended by connecting with tape and others. The paper may be detected incorrectly by the connected line, and rubbed by the print head and become contaminated, or the paper may jam.

| Paper type | Category | Form | Width |
|--|---|---------------|--|
| Continuous paper | Plain Matte | Roll paper | 30 to 108 mm {1.18 to 4.25"} (Paper width) |
| Continuous paper (Blackmark) | Plain Matte | Roll paper | 30 to 108 mm {1.18 to 4.25"} (Paper width) |
| Continuous paper (Blackmark) | Plain Matte | Fanfold paper | 50 to 108 mm {1.97 to 4.25"} (Paper width) |
| Full-page label Transparent full-page label | Plain label Matte label Synthetic label Glossy label | Roll paper | 25.4 to 108 mm {1 to 4.25"} (Label width) |
| Die-cut label (Gap) Transparent die-cut label | Plain label Matte label Synthetic label Glossy label | Roll paper | 25.4 to 108 mm {1 to 4.25"} (Label width) |

| Paper type | Category | Form | Width |
|---------------------------|--|---------------|--|
| Die-cut label (Blackmark) | Plain label Matte label Glossy label | Roll paper | 25.4 to 108 mm {1 to 4.25"} (Label width) |
| Die-cut label (Blackmark) | Plain label Matte label | Fanfold paper | 46 to 108 mm {1.81 to 4.25"} (Label width) |
| Wristband | Wristband | Roll paper | 30 mm {1.18"} (Paper width) |

Continuous paper

This is continuous paper.

| | |
|-------------------|--|
| Media type | Plain / Matte |
| Media source | Roll paper |
| Paper width | 30 to 108 mm {1.18 to 4.25"} |
| Paper thickness | 0.084 to 0.124 mm {0.003 to 0.004"} |
| Paper core | External diameter: 44.1 mm {1.74"} or more |
| External diameter | Maximum 101.6 mm {4"} |
| Winding direction | Printing face must be facing outside. |

CAUTION

Do not use the paper with a hole or cutout.

Continuous paper (Blackmark)

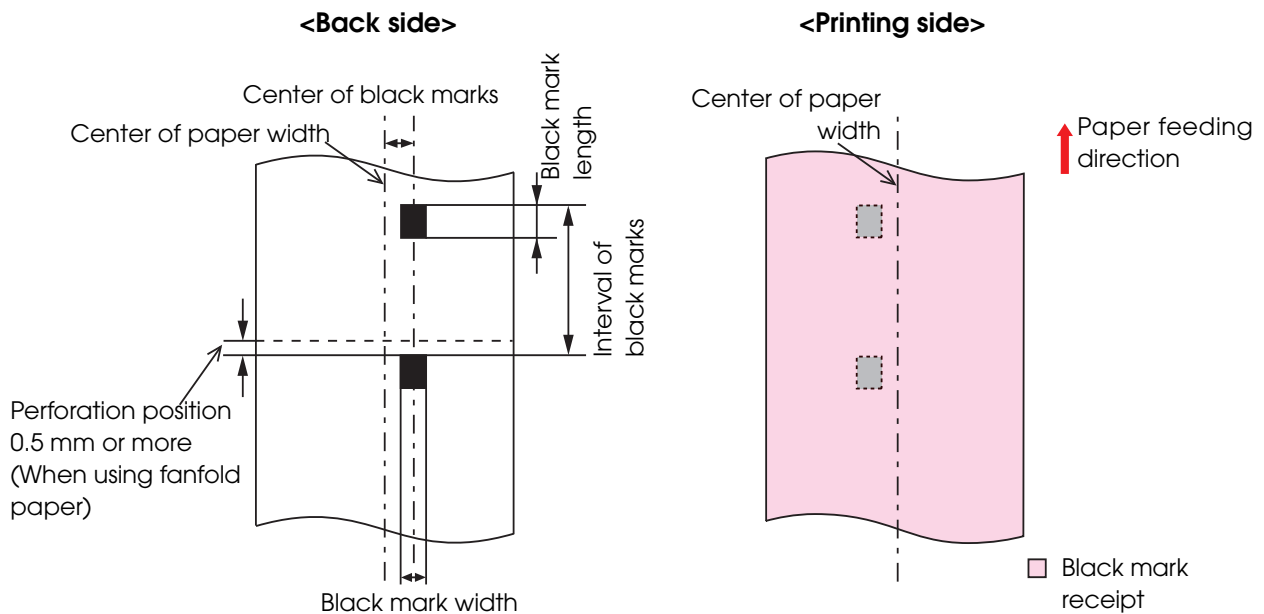

| | |
|--------------------------|--|
| Media type | Plain / Matte |
| Media source | Roll paper |
| Paper width | 30 to 108 mm {1.18 to 4.25"} |
| Black mark width | 13 mm {0.51"} or more |
| Black mark length | 4 mm {0.16"} or more (with a width of at least 4 mm around) |
| Center of a black mark | 8.5 mm \pm 1 mm {0.33 \pm 0.039"} |
| Gaps between black marks | 8 to 1117.6 mm {0.32 to 44"} |
| Paper thickness | 0.084 to 0.124 mm {0.003 to 0.004"} |
| Paper core | External diameter: 44.1 mm {1.74"} or more |
| External diameter | Maximum 101.6 mm {4"} |
| Winding direction | Printing face must be facing outside. |

CAUTION

Do not use the paper with a hole or cutout.

| | |
|--------------------------|--|
| Media type | Plain / Matte |
| Media source | Fanfold paper |
| Paper width | 50 to 108 mm {1.97 to 4.25"} |
| Black mark width | 13 mm {0.51"} or more |
| Black mark length | 4 mm {0.16"} or more (with a width of at least 4 mm around) |
| Center of a black mark | 8.5 mm \pm 1 mm {0.33 \pm 0.039"} |
| Gaps between black marks | 8 to 304.8 mm {0.32 to 12.0"} |
| Paper thickness | 0.124 to 0.128 mm {0.0047 to 0.005"} |
| Gaps of perforated line | 203.2 to 304.8 mm {8 to 12"} |
| Form of perforated line | Plain media : 1 mm {0.039"} uncut, 5 mm {0.2"} cut Fine media : 1 mm {0.039"} uncut, 5 mm {0.2"} cut PET film : 0.6 mm uncut, 8.4 mm cut |
| Number of folds | 500 or less |

CAUTION

- Do not use the paper with a hole or cutout.
- Autocutting on the perforated lines may generate minute paper dust, causing machine problems. Also, autocutting ahead of the perforated line may cause problems when feeding paper. Therefore, autocutting must be performed 0.5 mm to 1 mm {0.02 to 0.039"} behind the perforated line.
- Black marks must position away at least 0.5 mm {0.02"} from the perforated line.
- The perforated lines on both sides of the paper edge must be left uncut.
- Make sure to keep the same position of the black marks to the perforated lines (position that can be detected by black mark sensor) when inserting the paper from either side in order to use the paper inserting from reverse direction.

Full-page label

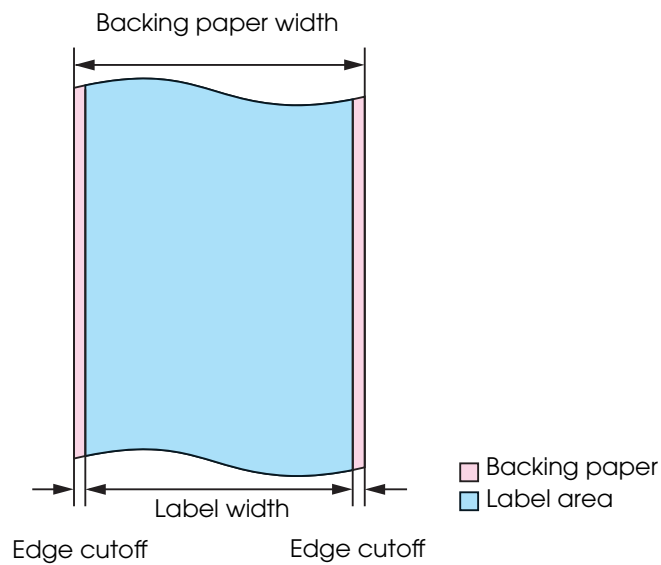

| | |
|----------------------------|---|
| Media type | Plain label / Matte label / Synthetic label / Glossy label |
| Media source | Roll paper |
| Backing paper width | 30 mm to 112 mm {1.18 to 4.41"} |
| Label width | 25.4 to 108 mm {1 to 4.25"} |
| Right and left outer edges | 2 mm \pm 0.5 mm {0.079 \pm 0.02"} |
| Paper thickness | Plain label / Matte label / Synthetic label: 0.129 to 0.195 mm {0.005 to 0.008"} Glossy label: 0.184 mm {0.007"} |
| Paper core | Plain label / Matte label / Synthetic label: External diameter: 44.1 mm {1.74"} or more Glossy label: External diameter: 56.8 mm {2.24"} or more |
| External diameter | Maximum 101.6 mm {4"} |
| Winding direction | Printing face must be facing outside. |

CAUTION

- Do not use the paper with a hole or cutout.
- To prevent glue from sticking to the roll paper supply unit, use label paper whose outer edges are removed only on the right and left.

Die-cut label(Gap)

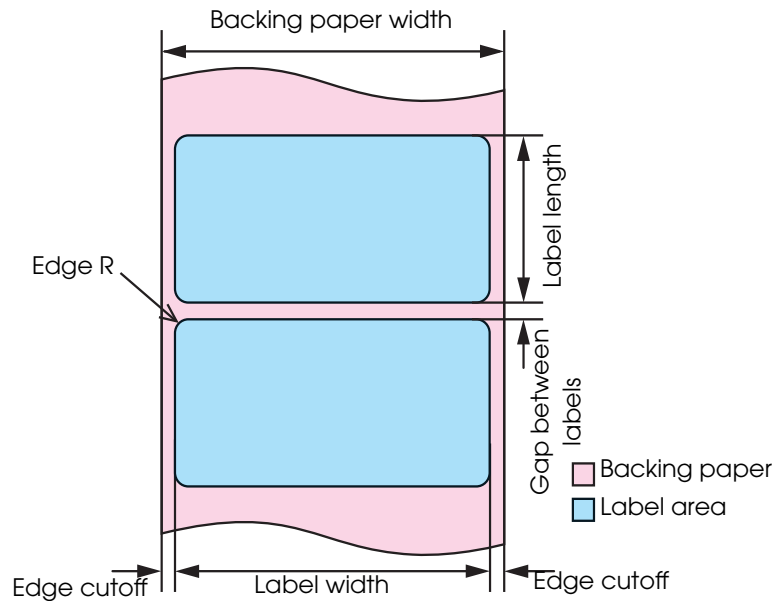

| | |
|----------------------------|--|
| Media type | Plain label / Matte label / Synthetic label / Glossy label |
| Media source | Roll paper |
| Backing paper width | 30 to 112 mm {1.18 to 4.41"}} |
| Label width | 25.4 to 108 mm {1 to 4.25"}} |
| Label length | 8 to 1,117.6 mm {0.32 to 44"}} |
| Gap between labels | 3 to 6 mm {0.12 to 0.24"}} |
| Left and right outer edges | 2 mm \pm 0.5 mm {0.079 \pm 0.02"}} |
| Label edge R | 1.5 mm {0.059"} or less |
| Paper thickness | Plain label / Matte label / Synthetic label: 0.129 to 0.195 mm {0.005 to 0.008"} Glossy label: 0.184mm {0.007"}} |
| Paper core | Plan label / Synthetic label: External diameter: 44.1 mm {1.74"} or more Matte label / Glossy label: External diameter: 56.8 mm {2.24"} or more |
| External diameter | Maximum 101.6 mm {4"}} |
| Winding direction | Printing face must be facing outside. |
| Form of perforated line | Plain media : 1 mm {0.039"} uncut, 5 mm {0.2"} cut Fine media : 1 mm {0.039"} uncut, 5 mm {0.2"} cut PET film : 0.6 mm uncut, 8.4 mm cut |

CAUTION

- Do not use the paper with a hole or cutout.
- If the backing is synthetic media or film, it will be difficult to cut by hand even if there is a perforation, so do not use the perforation.

Die-cut label (Blackmark)

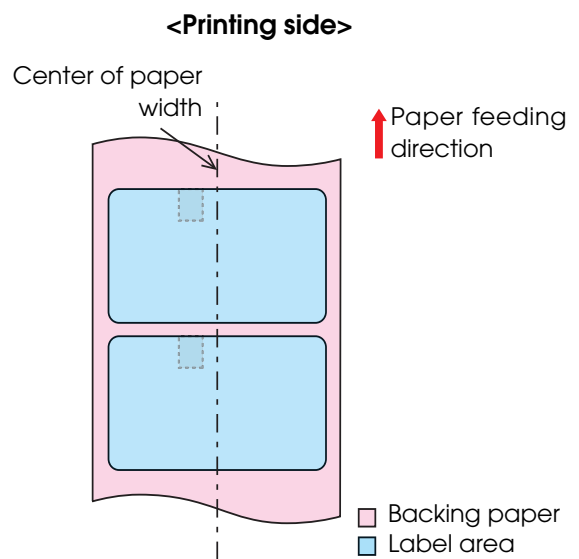
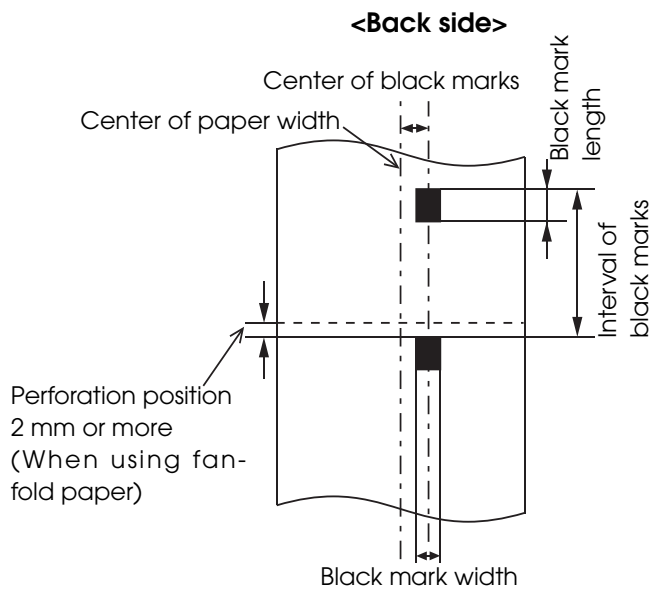
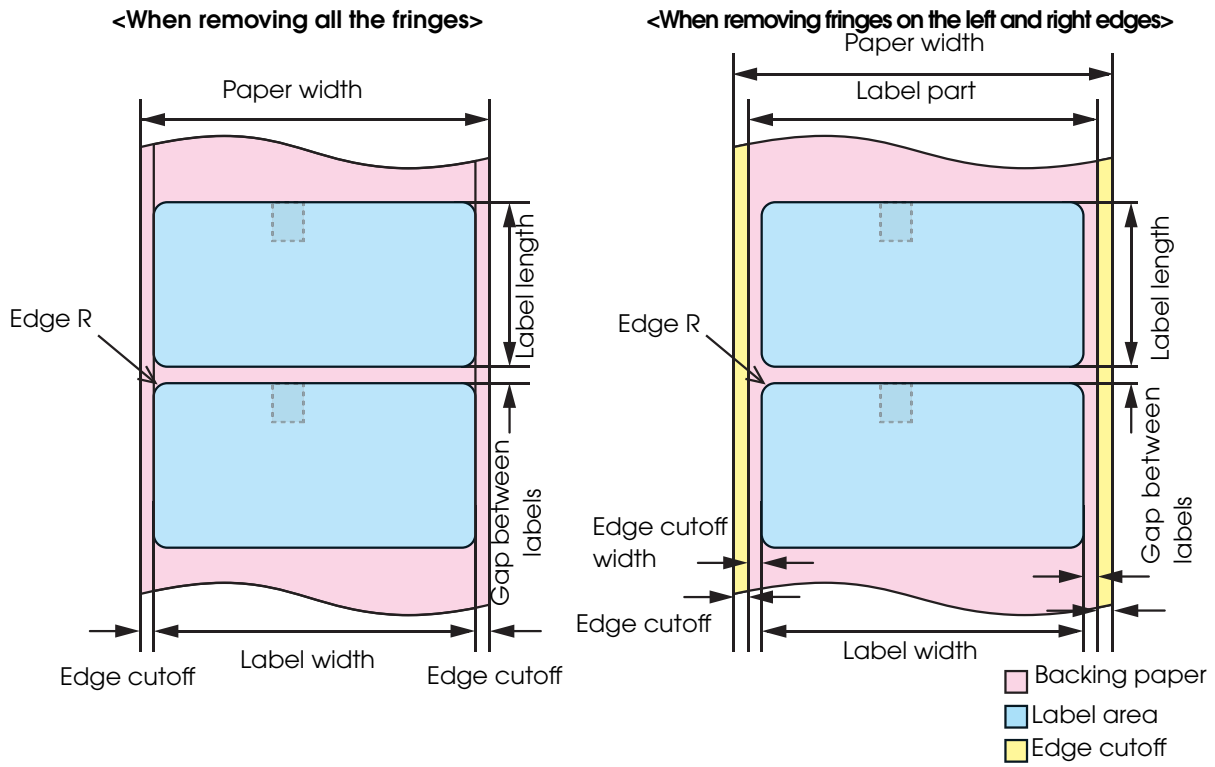

| | |
|----------------------------|--|
| Media type | Plain label / Matte label / Glossy label |
| Media source | Roll paper |
| Backing paper width | 30 to 112 mm {1.18 to 4.41"} |
| Label width | 25.4 to 108 mm {1 to 4.25"} |
| Label length | 8 to 1,117.6 mm {0.32 to 44"} |
| Gap between labels | 3 to 6 mm {0.12 to 0.24"} |
| Left and right outer edges | 2 mm \pm 0.5 mm {0.079 \pm 0.02"} |
| Edge cutoff width | 1.5 mm or more |
| Label edge R | 1.5 mm {0.059"} or less |
| Width of a black mark | 13 mm {0.51"} or more |
| Length of a black mark | 4 mm {0.16"} or more (with a width of at least 4 mm around) |
| Center of a black mark | 8.5 mm \pm 1 mm {0.33 \pm 0.039"} |
| Gaps between black marks | 11 to 1,123.6 mm {0.43 to 44.24"} |
| Paper thickness | Plain label / Matte label: 0.129 to 0.143 mm {0.005 to 0.006"} Glossy label: 0.184 mm {0.007"} |
| Paper core | Plain label: outer diameter 44.1 mm {1.74"} or more Matte label / Glossy label: outer diameter 56.8 mm {2.24"} or more |
| External diameter | Maximum 101.6 mm {4"} |
| Winding direction | Printing face must be facing outside. |
| Form of perforated line | Plain media : 1 mm {0.039"} uncut, 5 mm {0.2"} cut Fine media : 1 mm {0.039"} uncut, 5 mm {0.2"} cut PET film : 0.6 mm uncut, 8.4 mm cut |

CAUTION

- Do not use the paper with a hole or cutout.
- For the black mark position of the die-cut label paper, match the label edge to the black mark edge.
- You can use paper with all fringes removed or paper with fringes on the left and right removed.

| | |
|----------------------------|--|
| Media type | Plain label / Matte label |
| Media source | Fanfold paper |
| Backing paper width | 50 to 112 mm {1.97 to 4.41"} |
| Label width | 46 to 108 mm {1.81 to 4.25"} |
| Label length | 8 to 301.8 mm {0.32 to 11.88"} |
| Gap between labels | 3 to 6 mm {0.12 to 0.24"} |
| Left and right outer edges | 2 mm \pm 0.5 mm {0.079 \pm 0.02"} |
| Edge cutoff width | 1.5 mm or more |
| Label edge R | 1.5 mm {0.059"} or less |
| Width of a black mark | 13 mm {0.51"} or more |
| Length of a black mark | 4 mm {0.16"} or more (with a width of at least 4 mm around) |
| Center of a black mark | 8.5 mm \pm 1 mm {0.33 \pm 0.039"} |
| Gaps between black marks | 11 to 304.8 mm {0.43 to 12.0"} |
| Paper thickness | 0.161 to 0.164 mm {0.0063 to 0.0065"} |
| Perforated line pitch | 203.2 to 304.8 mm {8 to 12"} |
| Form of perforated line | Plain media : 1 mm {0.039"} uncut, 5 mm {0.2"} cut Fine media : 1 mm {0.039"} uncut, 5 mm {0.2"} cut PET film : 0.6 mm uncut, 8.4 mm cut |
| Number of folds | 500 or less |

CAUTION

- Do not use the paper with a hole or cutout.
- Autocutting on the perforated lines may generate minute paper dust, causing machine problems. Also, autocutting ahead of the perforated line may cause problems when feeding paper. Therefore, autocutting must be performed 0.5 mm to 1 mm {0.02 to 0.039"} behind the perforated line.
- When using fanfold paper, the black marks must be at least 2 mm {0.079"} from the perforated lines.
- As for the black mark position on the die-cut label paper, match the label edge and the black mark edge.
- The perforated lines on both sides of the paper edge must be left uncut.
- You can use paper with all fringes removed or paper with fringes on the left and right removed.
- By setting the black marks on both sides, you can insert paper from either side.

<Back side>

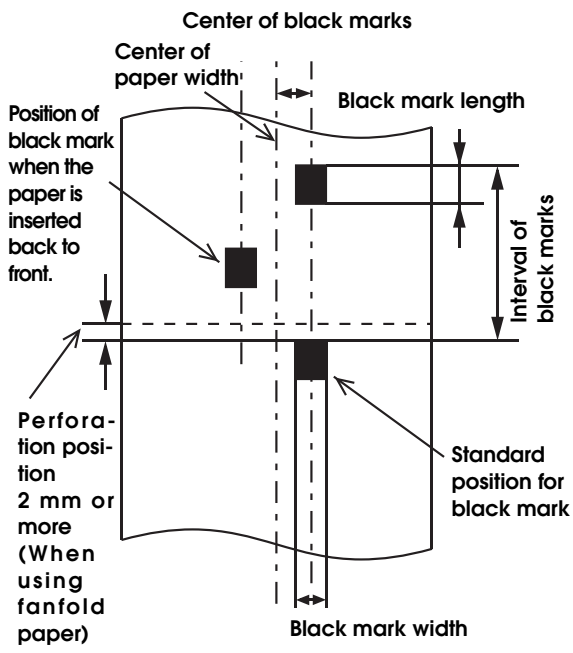

<Printing side>

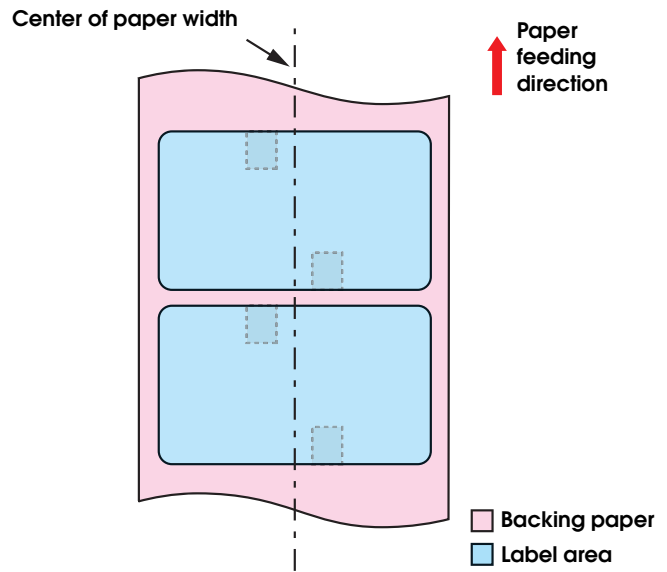

Print Area and Cutting Position

Continuous paper / Roll paper

When "Borderless Printing" is disabled

Top, bottom, left, right margins: 1.5 mm (Typical value)

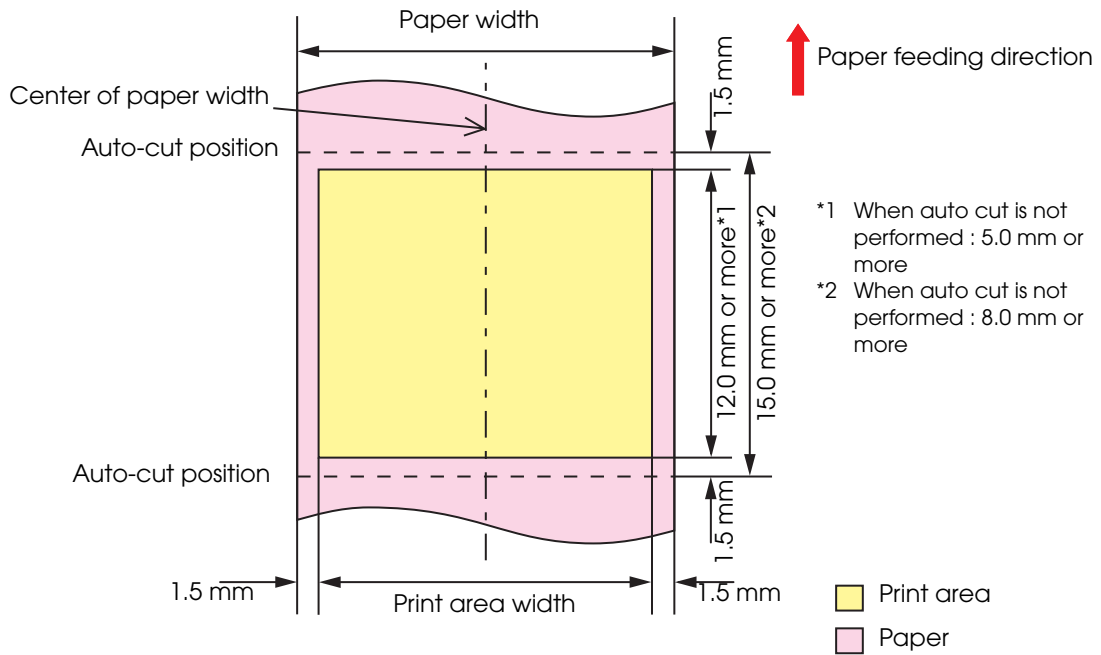

CAUTION

When the roll paper option is set to "Banner Mode," a top margin is set only on the first page of the print job, and not on the rest. A bottom margin is set on the last page of the print job.

When "Borderless Printing" is enabled

Top, bottom, left, right margins: 0 mm (Typical value)

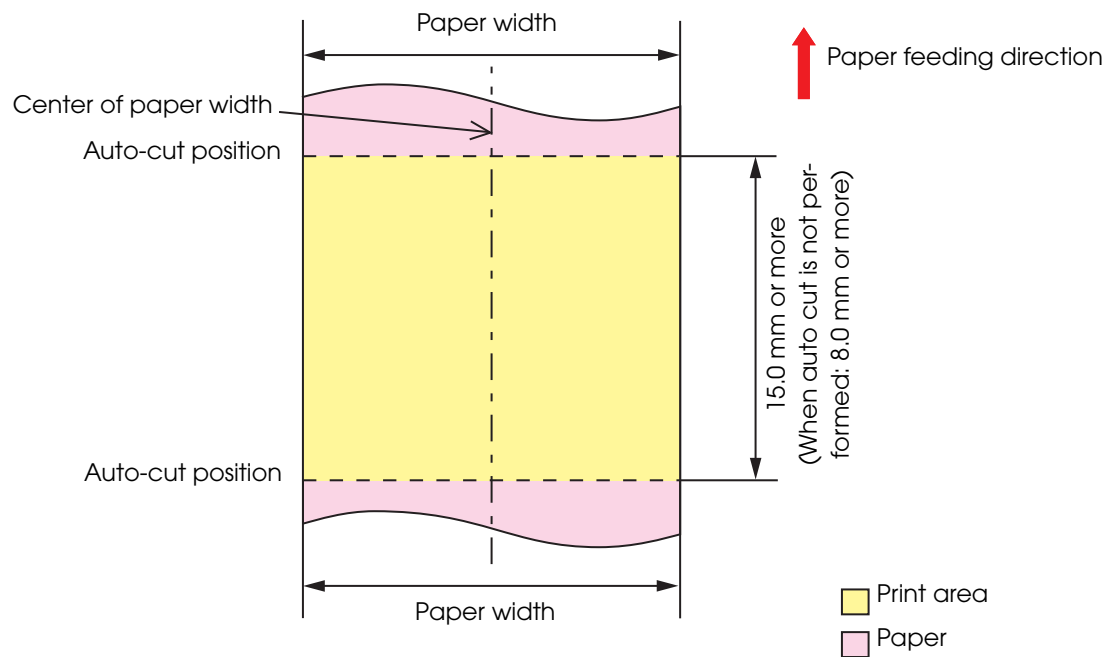

CAUTION

- If you enabled "Borderless Printing", printing is done with settings for no margins, but the printing might protrude beyond the paper/label, depending on the actual print position and the set position for the paper/label. To make sure printing does not protrude out, ensure margins of 1.5 mm {0.06"} or more in the print data.
- Even if "Borderless Printing" is enabled, the maximum value for the print area width is 104 mm {4.09"}.

Continuous paper (Blackmark) / Roll paper

When "Borderless Printing" is disabled

Top, bottom, left, right margins: 1.5 mm (Typical value)

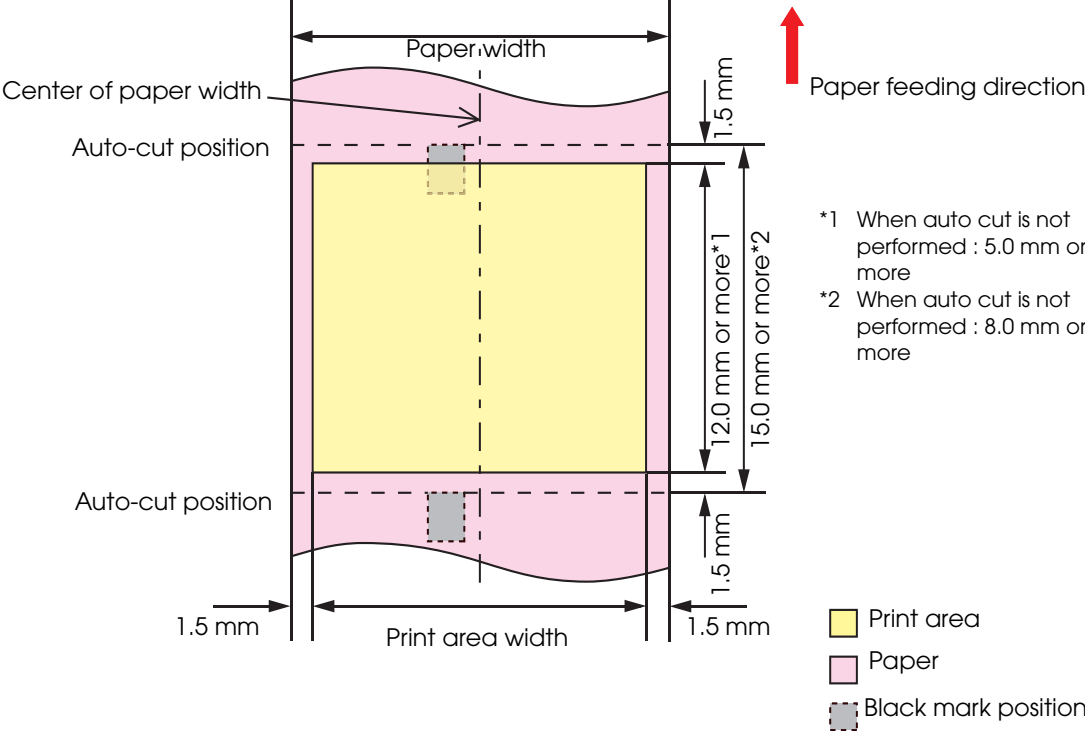

When "Borderless Printing" is enabled
 Top, bottom, left, right margins: 0 mm (Typical value)

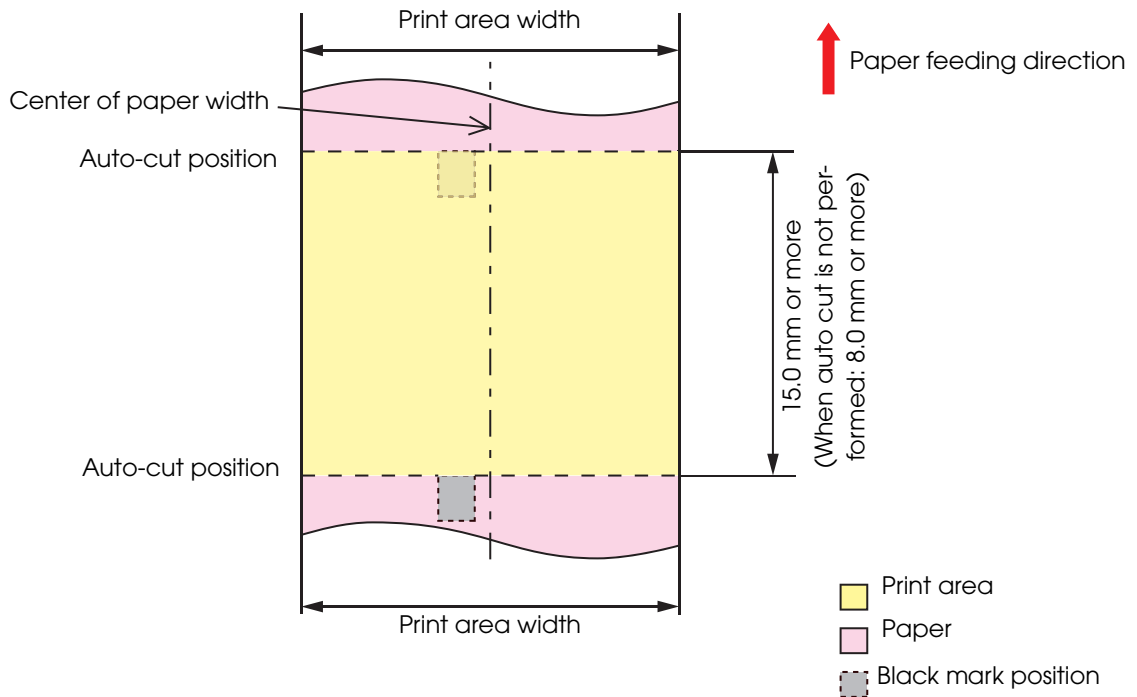

CAUTION

- If you enabled "Borderless Printing", printing is done with settings for no margins, but the printing might protrude beyond the paper/label, depending on the actual print position and the set position for the paper/label. To make sure printing does not protrude out, ensure margins of 1.5 mm {0.06"} or more in the print data.
- Even if "Borderless Printing" is enabled, the maximum value for the print area width is 104 mm {4.09"}.

Continuous paper (Blackmark) / Fanfold paper

When "Borderless Printing" is disabled

Top, bottom, left, right margins: 1.5 mm (Typical value)

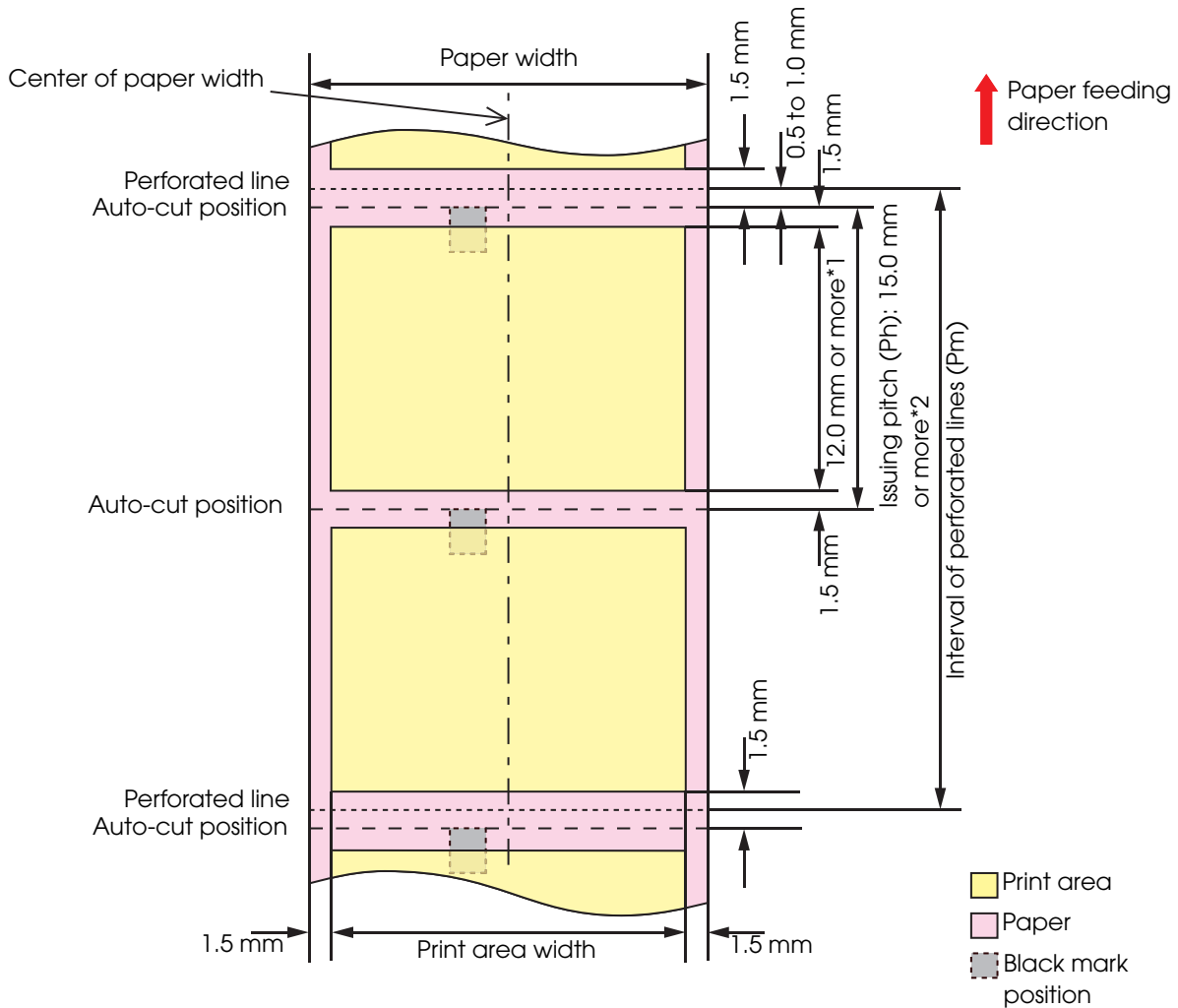

*1 When auto cut is not performed : 5.0 mm or more
 *2 When auto cut is not performed : 8.0 mm or more

When "Borderless Printing" is enabled
 Top, bottom, left, right margins: 0 mm (Typical value)

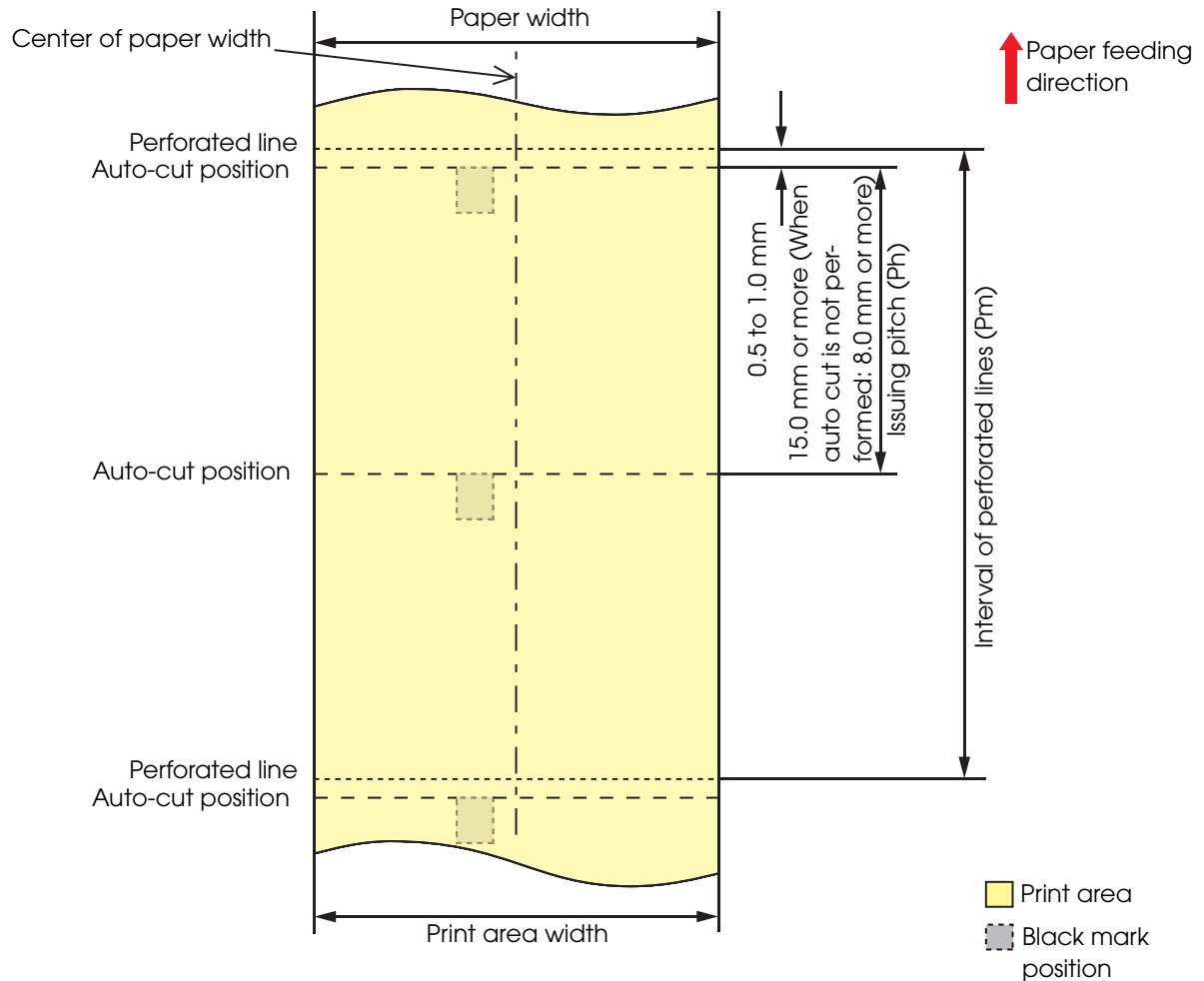

CAUTION

- If you enabled "Borderless Printing", printing is done with settings for no margins, but the printing might protrude beyond the paper/label, depending on the actual print position and the set position for the paper/label. To make sure printing does not protrude out, ensure margins of 1.5 mm {0.06"} or more in the print data.
- Even if "Borderless Printing" is enabled, the maximum value for the print area width is 104 mm {4.09"}.

Full-page label / Roll paper

When "Borderless Printing" is disabled

Top, bottom, left, right margins: 1.5 mm (Typical value)

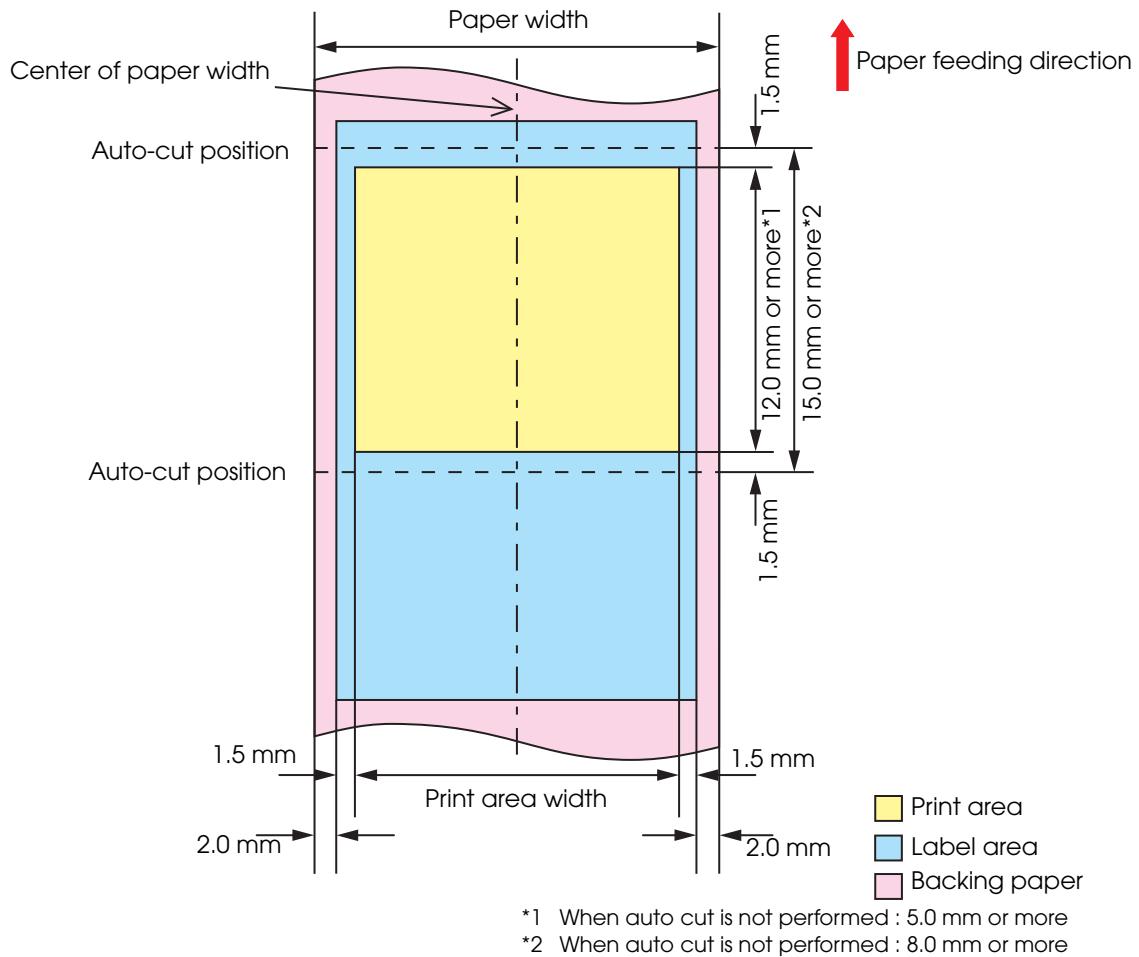

CAUTION

When the roll paper option is set to "Banner Mode," a top margin is set only on the first page of the print job, and not on the rest. A bottom margin is set on the last page of the print job.

When "Borderless Printing" is enabled
 Top, bottom, left, right margins: 0 mm (Typical value)

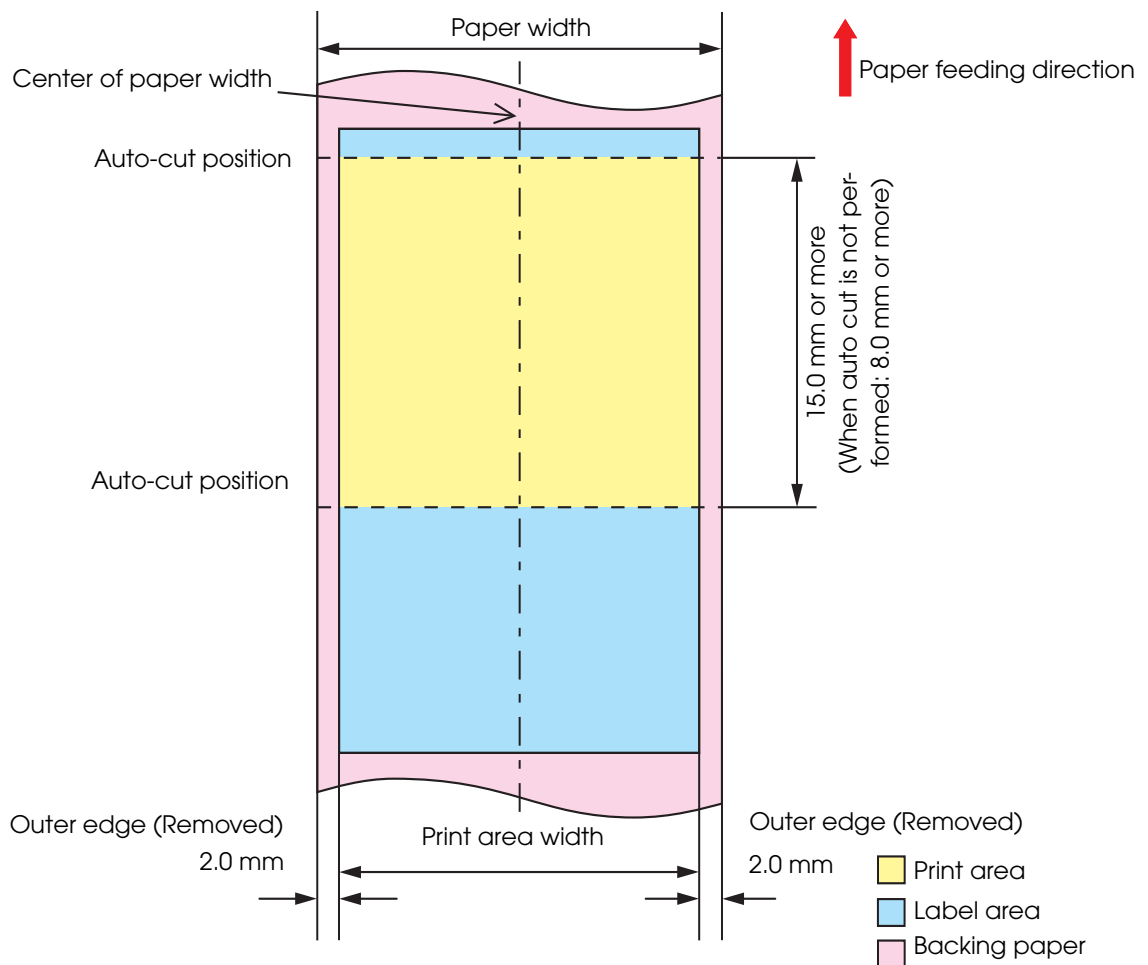

CAUTION

- If you enabled "Borderless Printing", printing is done with settings for no margins, but the printing might protrude beyond the paper/label, depending on the actual print position and the set position for the paper/label. To make sure printing does not protrude out, ensure margins of 1.5 mm {0.06"} or more in the print data.
- Even if "Borderless Printing" is enabled, the maximum value for the print area width is 104 mm {4.09"}.

Die-cut label(Gap) / Roll paper

When "Borderless Printing" is disabled

Top, bottom, left, right margins: 1.5 mm (Typical value)

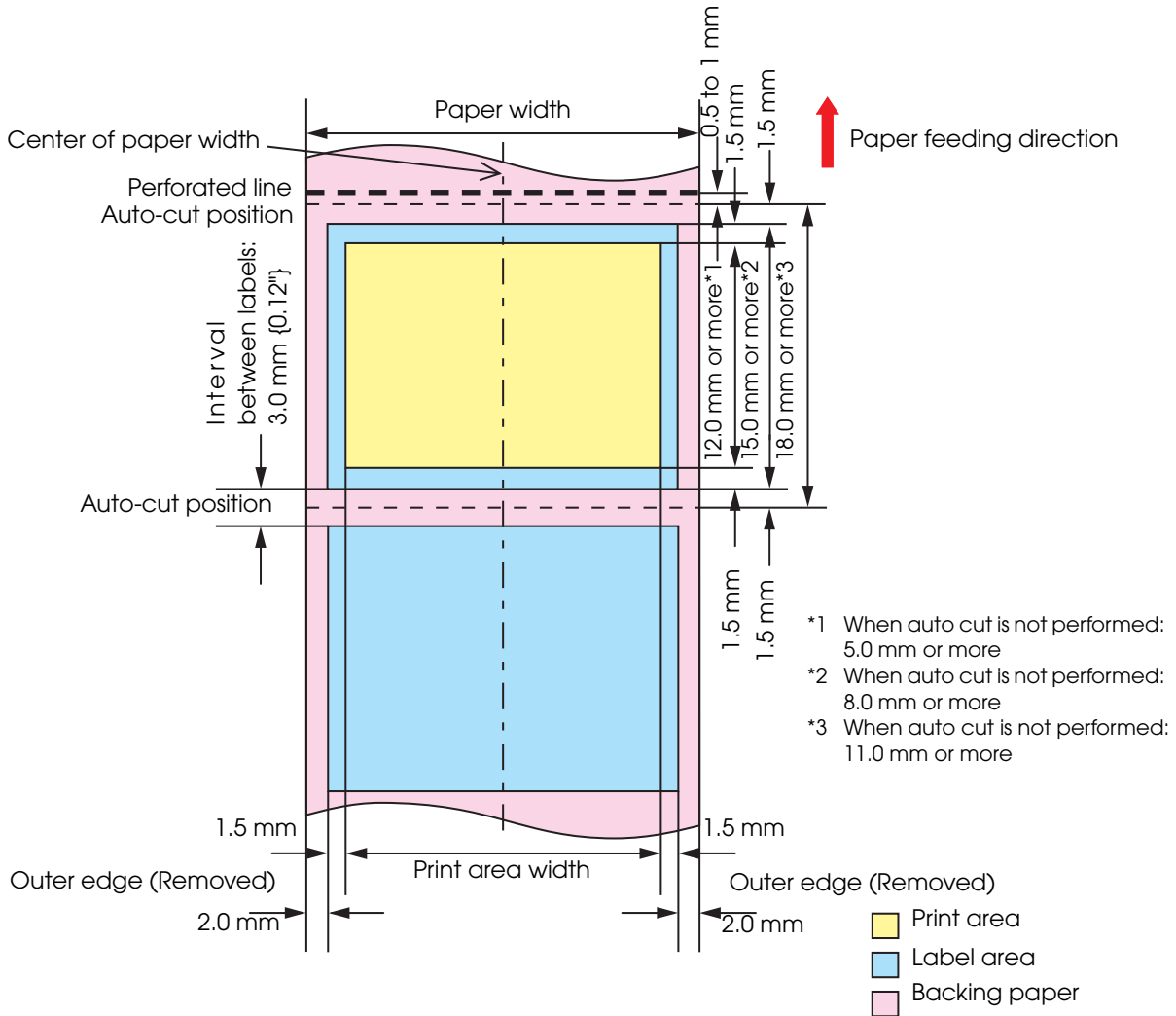

When "Borderless Printing" is enabled

Top, bottom, left, right margins: 0 mm (Typical value)

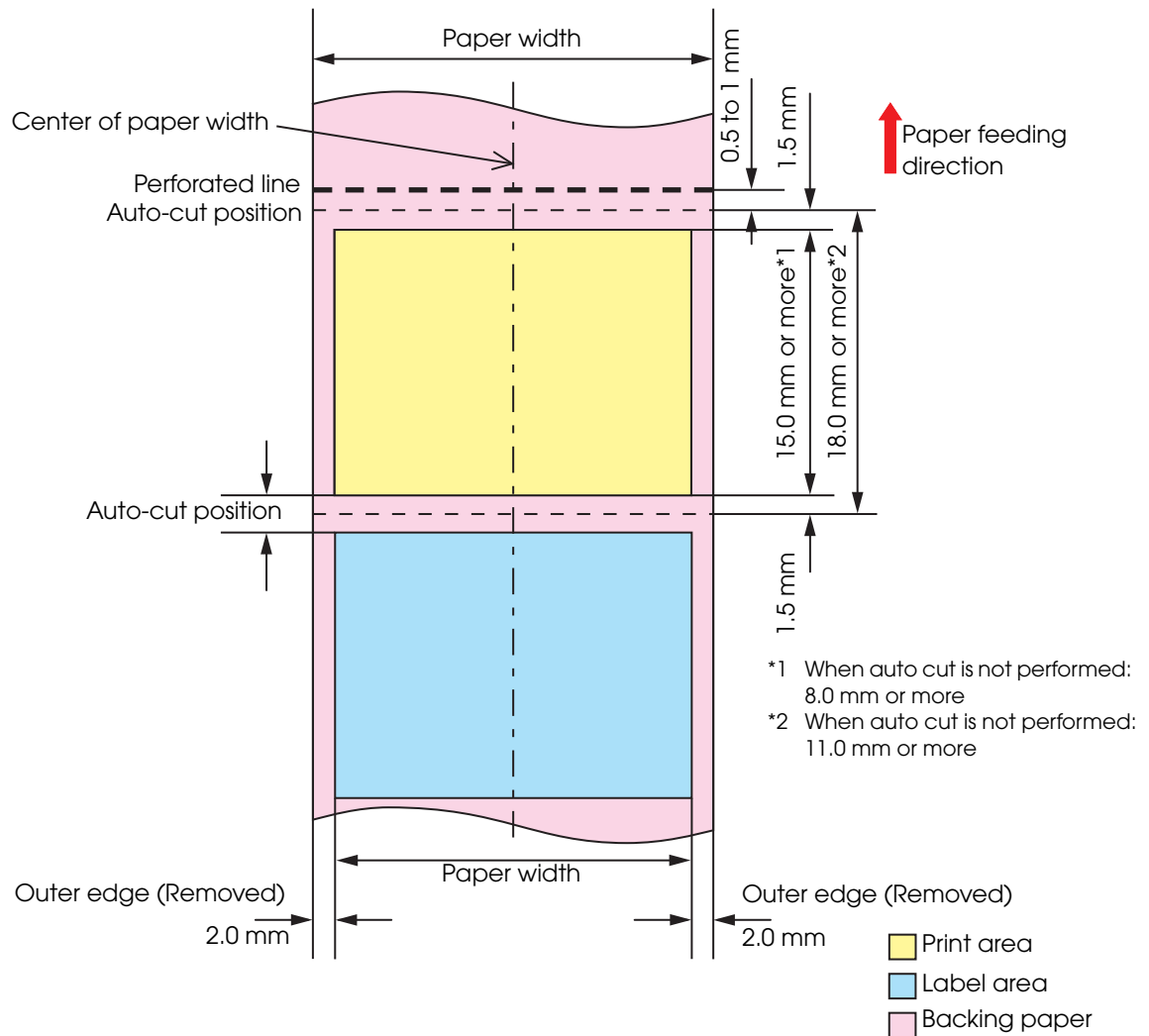
**CAUTION**

- If you enabled "Borderless Printing", printing is done with settings for no margins, but the printing might protrude beyond the paper/label, depending on the actual print position and the set position for the paper/label. To make sure printing does not protrude out, ensure margins of 1.5 mm {0.06"} or more in the print data.
- Even if "Borderless Printing" is enabled, the maximum value for the print area width is 104 mm {4.09"}.

Die-cut label (Blackmark) / Roll paper

When "Borderless Printing" is disabled

Top, bottom, left, right margins: 1.5 mm (Typical value)

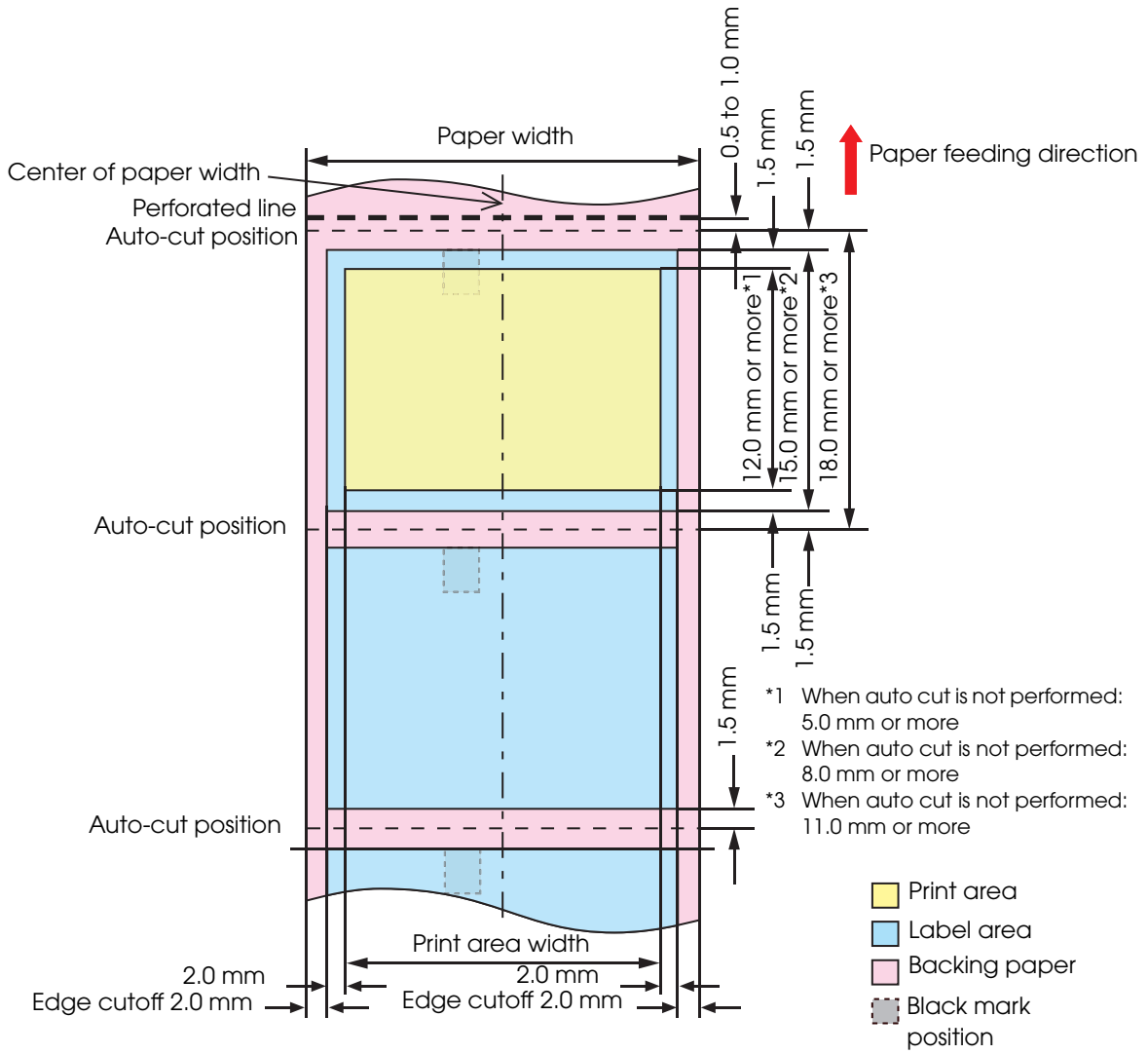

When "Borderless Printing" is enabled
 Top, bottom, left, right margins: 0 mm (Typical value)

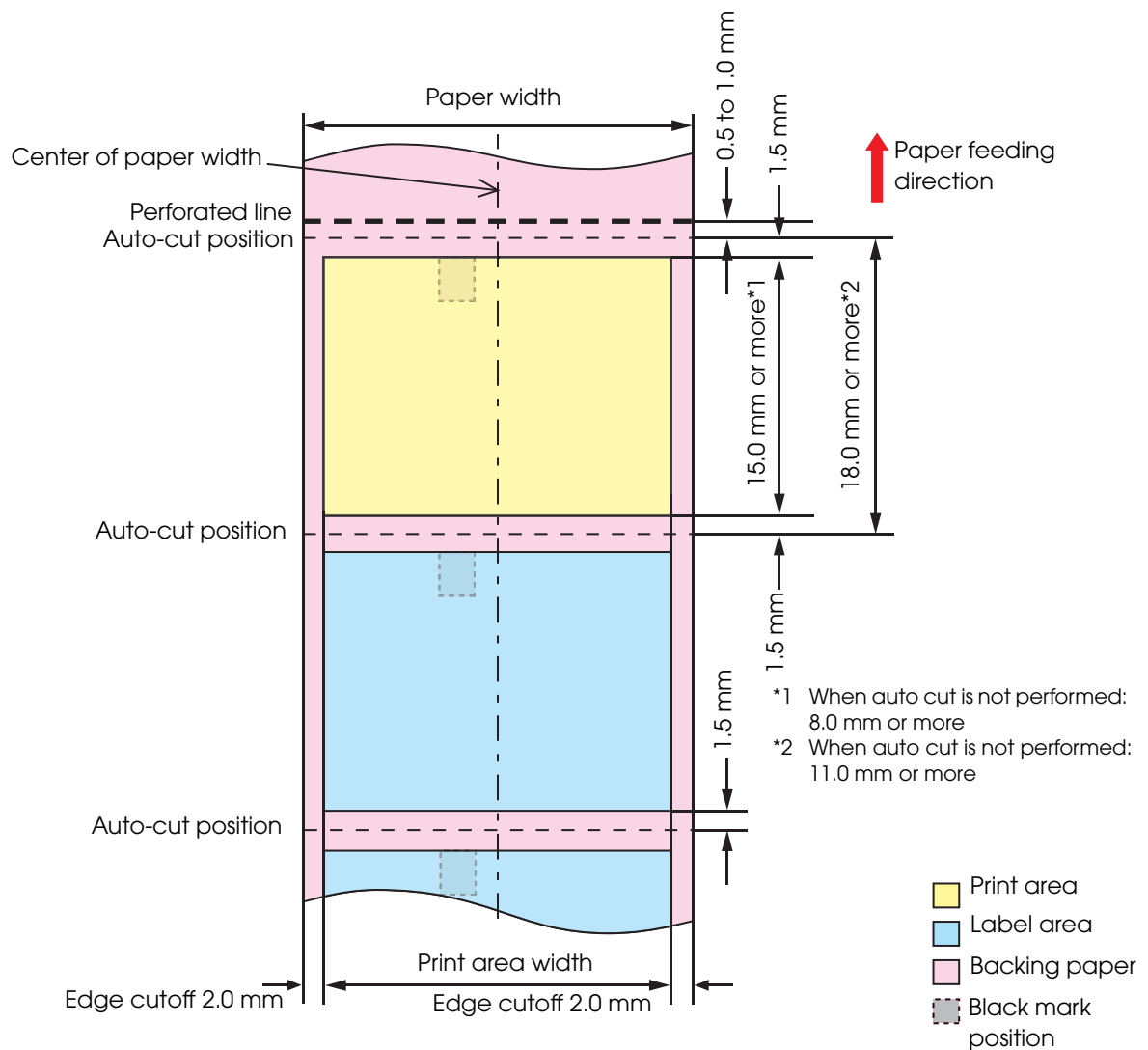
**CAUTION**

- If you enabled "Borderless Printing", printing is done with settings for no margins, but the printing might protrude beyond the paper/label, depending on the actual print position and the set position for the paper/label. To make sure printing does not protrude out, ensure margins of 1.5 mm {0.06"} or more in the print data.
- Even if "Borderless Printing" is enabled, the maximum value for the print area width is 104 mm {4.09"}.

Die-cut label (Blackmark) / Fanfold paper

When "Borderless Printing" is disabled

Top, bottom, left, right margins: 1.5 mm (Typical value)

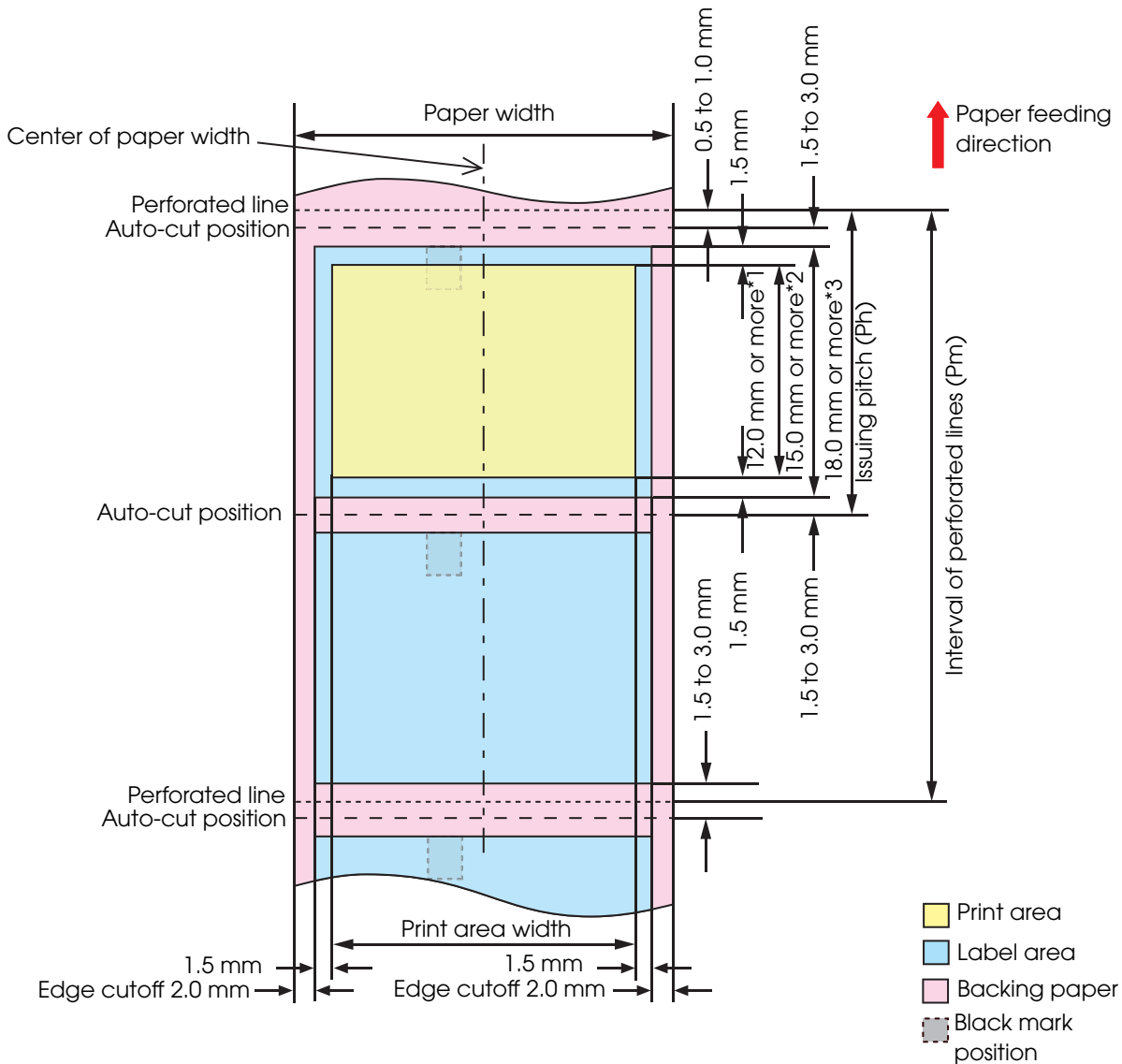

- *1 When auto cut is not performed: 5.0 mm or more
- *2 When auto cut is not performed: 8.0 mm or more
- *3 When auto cut is not performed: 11.0 mm or more

CAUTION

- Make sure to adjust perforated lines to an integral multiple of issuing pitch.
- The perforated line and print area overlap each other to destabilize printing or perforated line and the auto-cut position are misaligned to shorten the life of the autocutter if paper without black marks is used. Use paper with black marks on the back of the paper to adjust the paper position.

When "Borderless Printing" is enabled
 Top, bottom, left, right margins: 0 mm (Typical value)

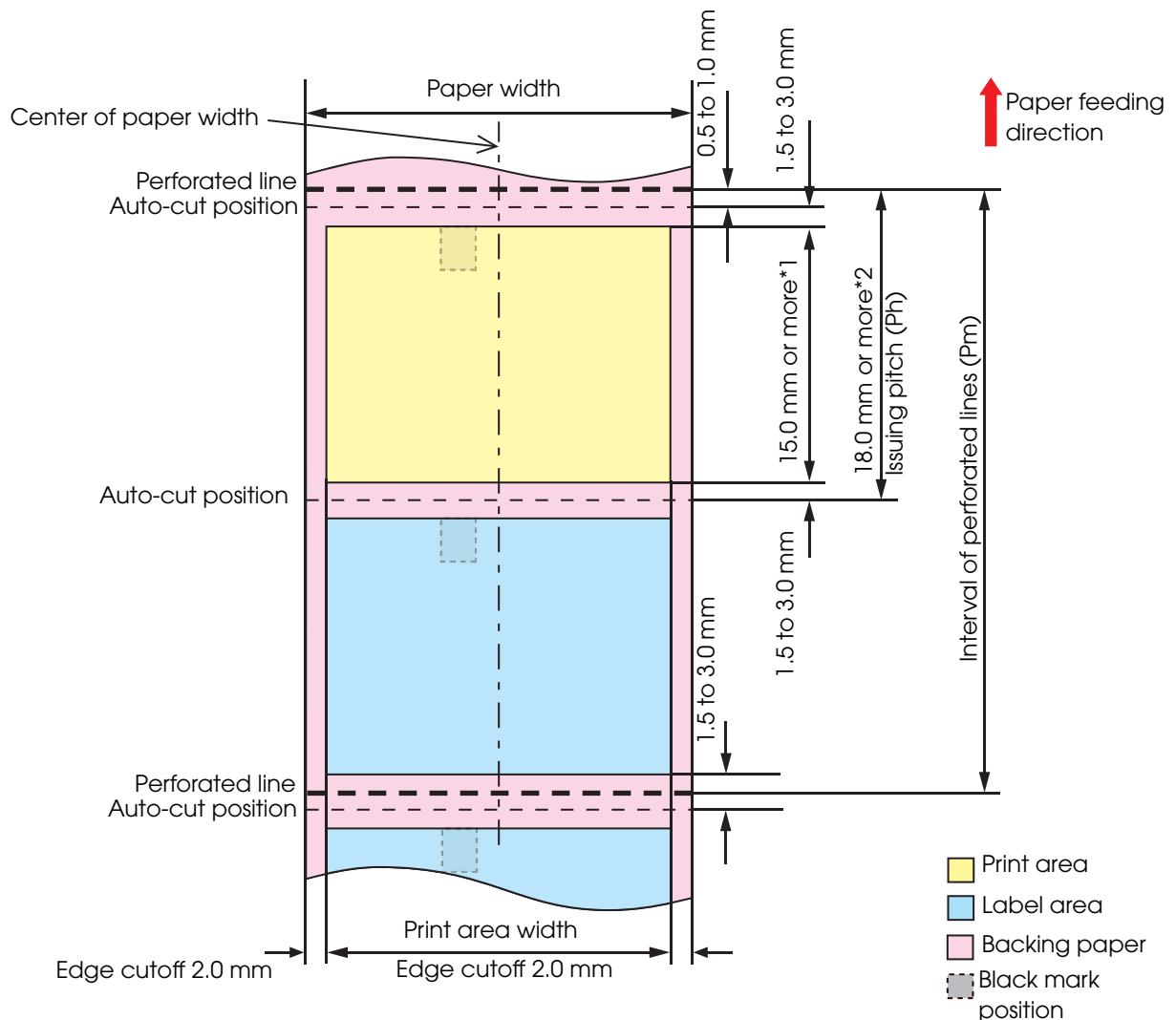

*1 When auto cut is not performed: 8.0 mm or more

*2 When auto cut is not performed: 11.0 mm or more

CAUTION

- If you enabled "Borderless Printing", printing is done with settings for no margins, but the printing might protrude beyond the paper/label, depending on the actual print position and the set position for the paper/label. To make sure printing does not protrude out, ensure margins of 1.5 mm {0.06"} or more in the print data.
- Even if "Borderless Printing" is enabled, the maximum value for the print area width is 104 mm {4.09"}.

Wristband/roll paper (WB-S series)

When "Borderless Printing" is disabled

Top, bottom, left, right margins: 1.5 mm (Typical value)

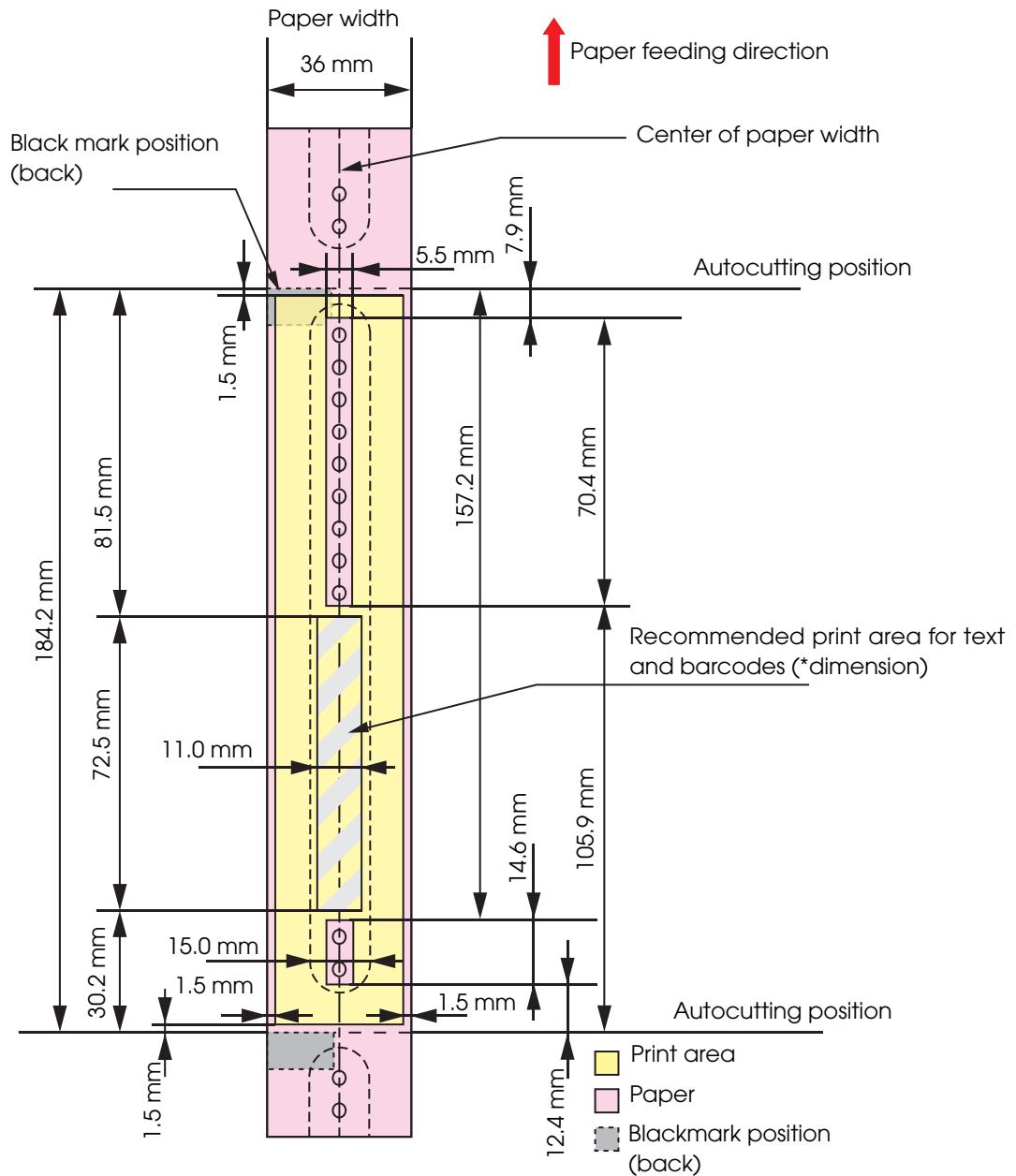

CAUTION

- Do not print inside or within 2 mm {0.08"} around the snap button mounting hole to prevent damage to the mechanical functions.
- If using the WB-S/M/L series, use the attachment (OT-WA34).

When "Borderless Printing" is enabled

Top, bottom, left, right margins: 0 mm (Typical value)

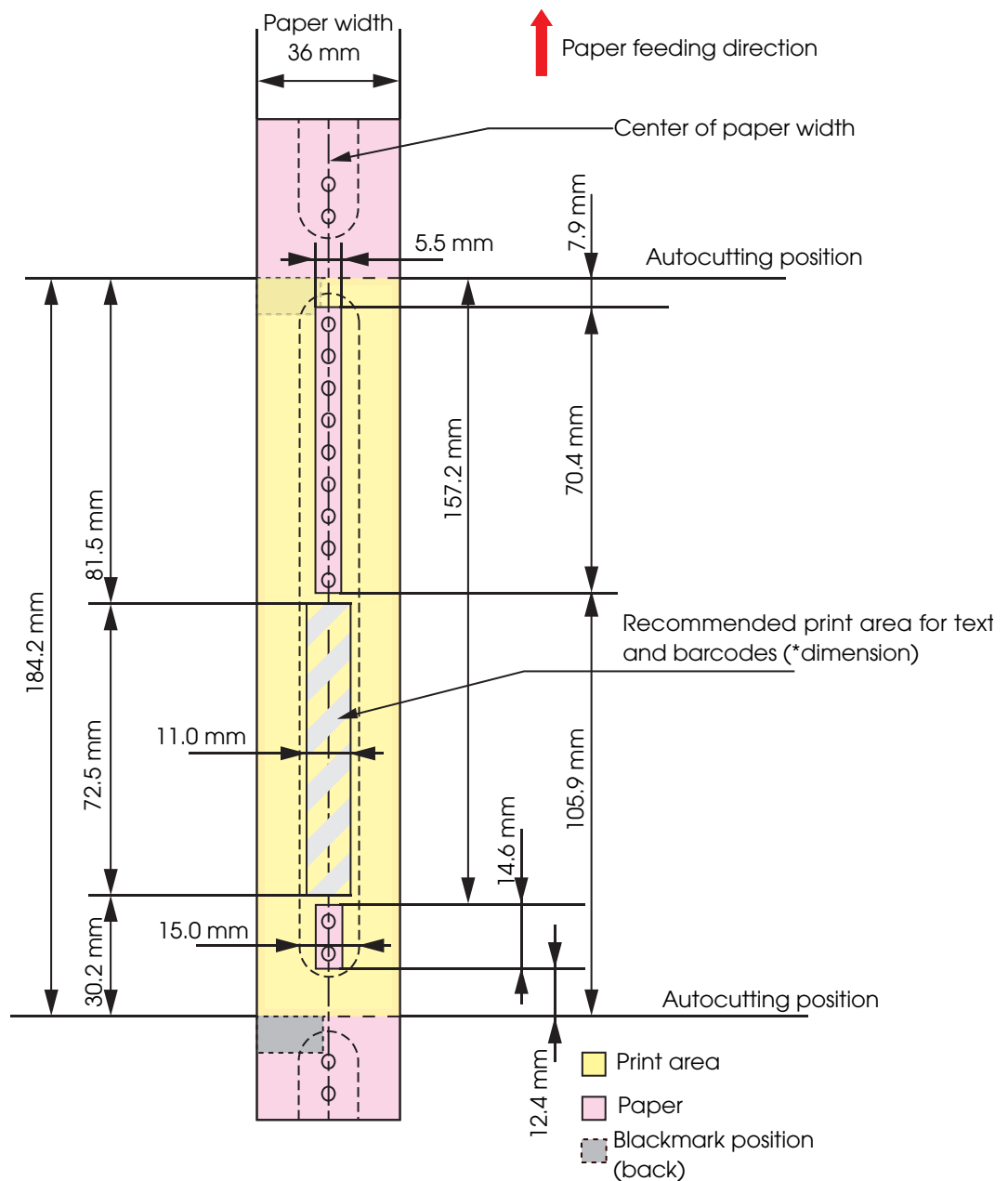

CAUTION

- Do not print inside or within 2 mm {0.08"} around the snap button mounting hole to prevent damage to the mechanical functions.
- If using the WB-S/M/L series, use the attachment (OT-WA34).
- If you enabled "Borderless Printing", printing is done with settings for no margins, but the printing might protrude beyond the paper/label, depending on the actual print position and the set position for the paper/label. To make sure printing does not protrude out, ensure margins of 1.5 mm {0.06"} or more in the print data.

Wristband/roll paper (WB-M series)

When "Borderless Printing" is disabled

Top, bottom, left, right margins: 1.5 mm (Typical value)

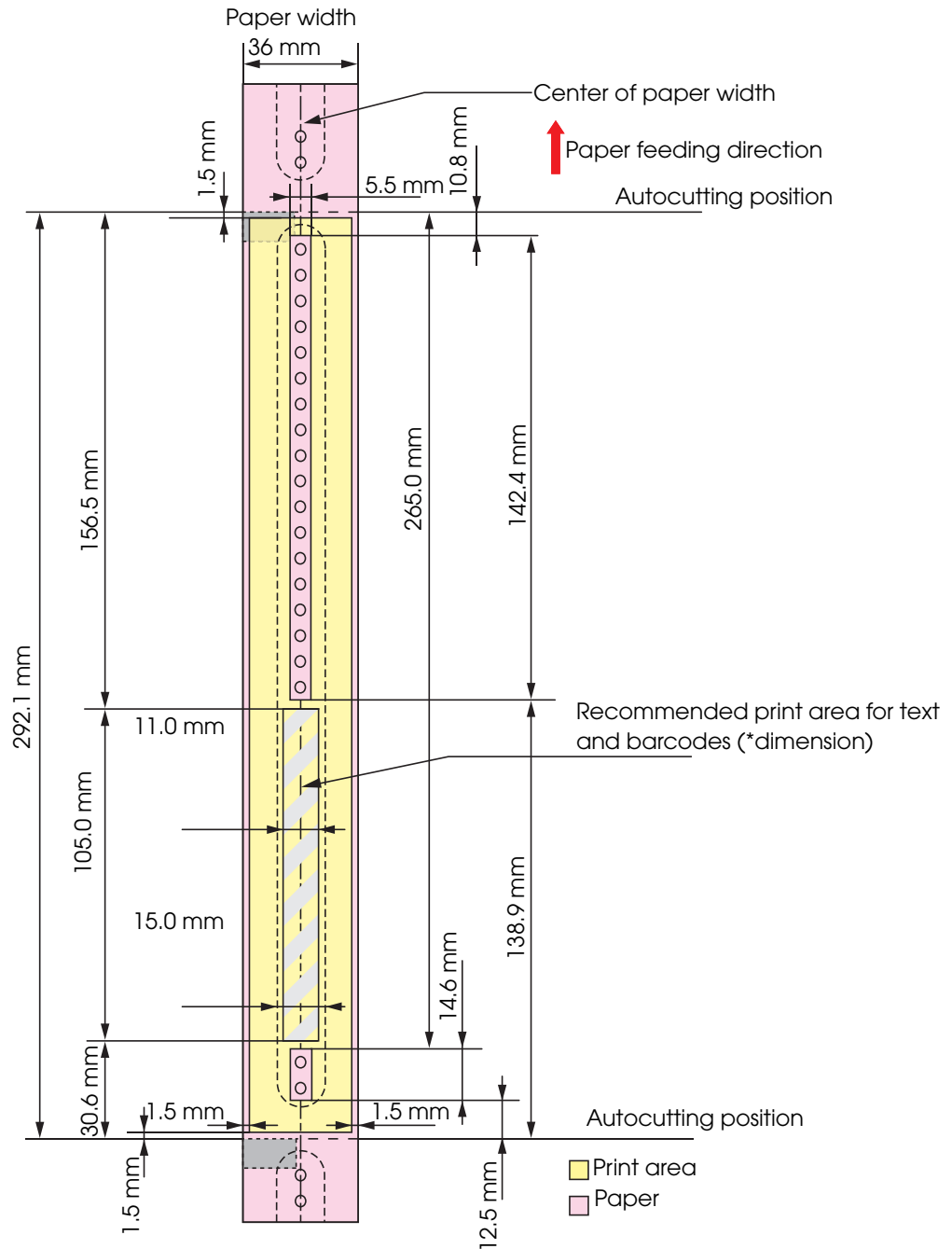

CAUTION

- Do not print inside or within 2 mm {0.08"} around the snap button mounting hole to prevent damage to the mechanical functions.
- If using the WB-S/M/L series, use the attachment (OT-WA34).

When "Borderless Printing" is enabled

Top, bottom, left, right margins: 0 mm (Typical value)

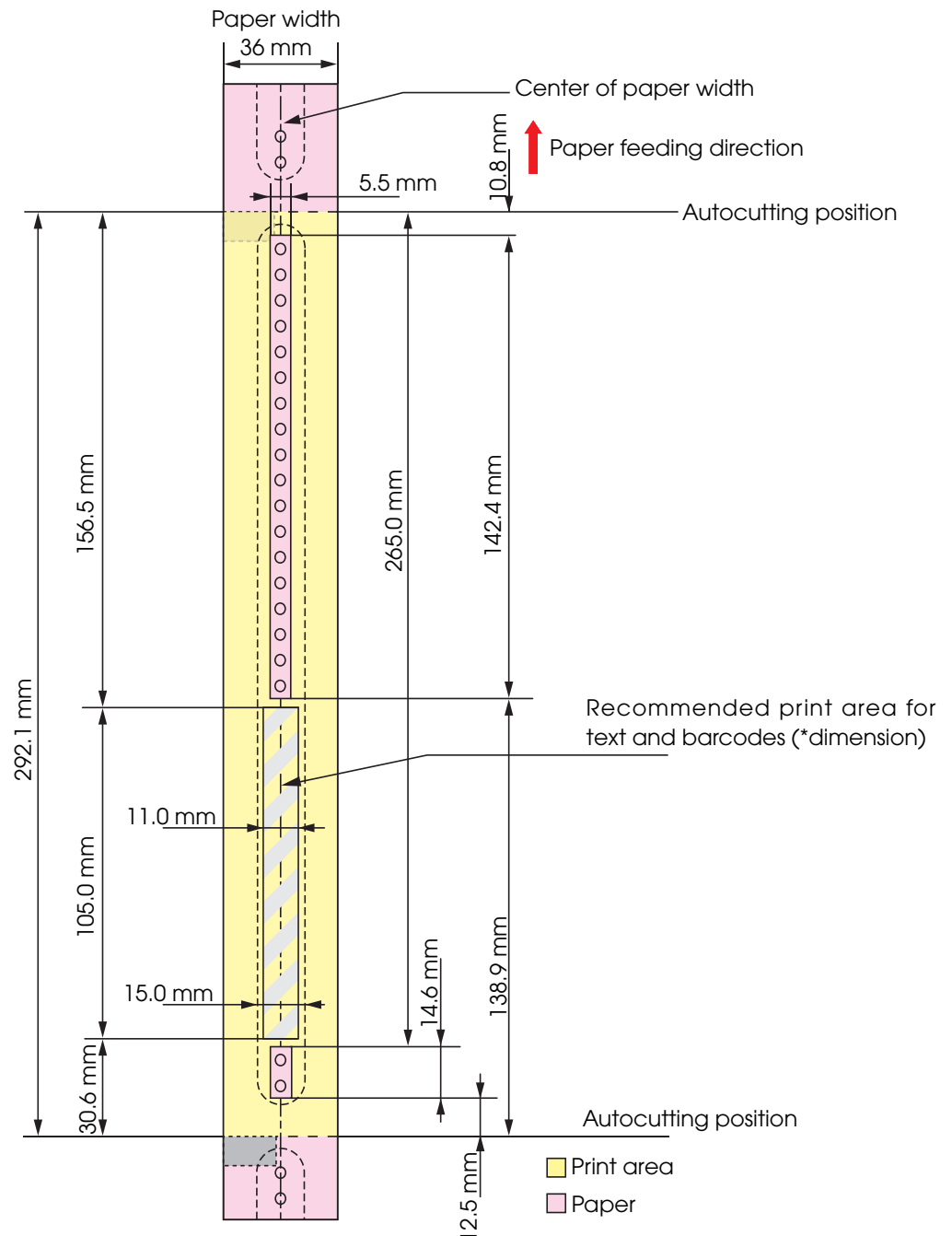

CAUTION

- Do not print inside or within 2 mm {0.08"} around the snap button mounting hole to prevent damage to the mechanical functions.
- If using the WB-S/M/L series, use the attachment (OT-WA34).
- If you enabled "Borderless Printing", printing is done with settings for no margins, but the printing might protrude beyond the paper/label, depending on the actual print position and the set position for the label. To make sure printing does not protrude out, ensure margins of 1.5 mm {0.06"} or more in the print data.

Wristband/roll paper (WB-L series)

When "Borderless Printing" is disabled

Top, bottom, left, right margins: 1.5 mm (Typical value)

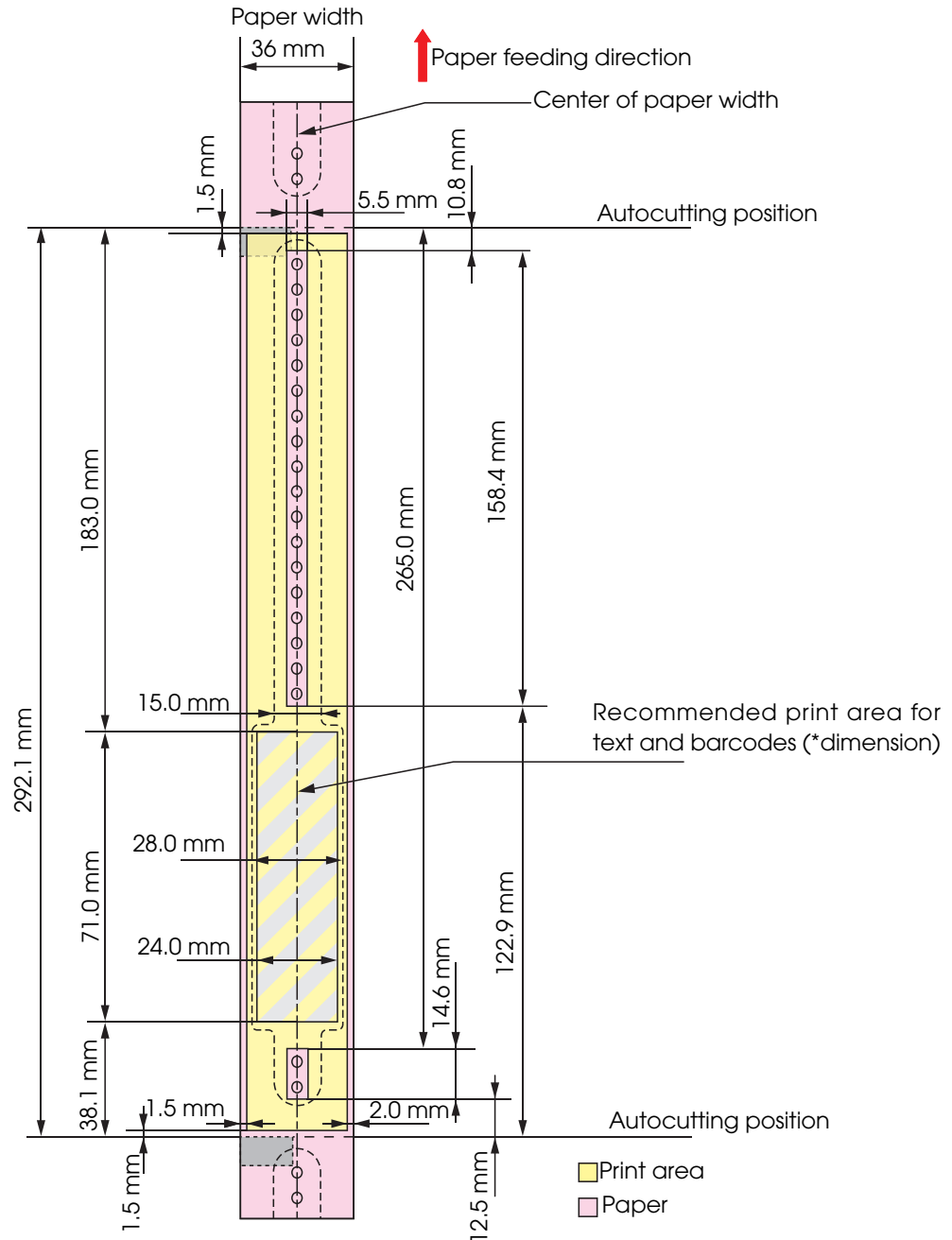

CAUTION

- Do not print inside or within 2 mm {0.08"} around the snap button mounting hole to prevent damage to the mechanical functions.
- If using the WB-S/M/L series, use the attachment (OT-WA34).

Paper Ejection Tray

NOTE

See the "Attaching the Paper Ejection Tray" on page 46.

| | | |
|------------------------------|-----------------|--|
| Continuous paper (Blackmark) | Paper type | Plain Media, Fine Media, PET Film |
| | Paper form | Fanfold paper |
| | Paper size | Width 76 to 105 mm × length 54 to 148 mm |
| | Paper thickness | 0.119 to 0.151 mm |
| Black Mark Die-cut Label | Paper type | Plain Media, Fine Media |
| | Paper form | Fanfold paper |
| | Paper size | Width 76 to 105 mm × length 54 to 148 mm |
| | Paper thickness | 0.145 to 0.161 mm |

CAUTION

- The paper ejection tray cannot store multiple sheets of roll paper.
- The paper ejection tray may not hold the paper perfectly, depending on the condition of the paper or printing.

Ink Cartridge

| | | |
|--------------|--|--------------------------------------|
| Model number | SJIC22P(K)/SJIC22P(C)/SJIC22P(M)/SJIC22P(Y) for TM-C3500 SJIC23P(K)/SJIC23P(C)/SJIC23P(M)/SJIC23P(Y) for TM-C3510 (Taiwan / Southeast Asia model) SJIC24P(K)/SJIC24P(C)/SJIC24P(M)/SJIC24P(Y) for TM-C3520 (China (Hong Kong) model) | |
| Type | 4 color-ink separated exclusive ink cartridge | |
| Ink color | Black, Cyan, magenta, yellow | |
| Ink type | Pigment ink | |
| Ink life | 6 months after loading to the printer, 2 years after manufacturing | |
| Temperatures | Transport | -20 to 60°C (up to 5 days for 60°C) |
| | Storage | -20 to 40°C (up to a month for 40°C) |
| | Installation | -20 to 40°C (up to a month for 40°C) |

Maintenance Box

| | |
|--------------|---|
| Model number | SJMB3500 |
| Type | Maintenance box with a built-in waste ink absorber |
| Life | None |
| Temperatures | Conforms to "Environmental Conditions" on page 232. |

Electrical Characteristics

| | | |
|-----------------------|----------------------|--------------------------------|
| Power supply | Dedicated AC adapter | |
| Input voltage (rated) | 100 V to 240 V | |
| Frequency (rated) | 50 Hz to 60 Hz | |
| Power consumption | Operating | Approximately 30W (Peak: 50 W) |
| | Stand-by | Approximately 2.5 W |
| | When power is OFF | Approximately 0.3 W |

CAUTION

- Use the dedicated AC adapter included in the product package.
- For the LAN cable, use cable with CAT5e or higher shielding.

Environmental Conditions

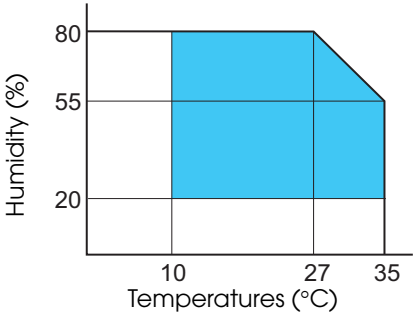
| Item | | Specification |
|---------------------------|--|--|
| Temperatures/ humidity | Printing | 10 to 35°C, 20 to 80%RH (no condensation)  |
| | Barcode printing | 15 to 35°C, 20 to 80%RH (no condensation) |
| | Storage | When packed (ink not loaded): -20 to 60°C, 5 to 85%RH (no condensation) -20°C or 60°C: up to 120 hours Ink loaded: -20 to 40°C -20°C: up to 120 hours 0 to 30°C: up to 6 months 40°C: up to a month |
| Pressure (elevation) | Operating | 850 to 1060 hPa (approximately 0 to 1500 m above sea level) |
| | Not operating (including in transportation) | 850 to 1060 hPa (approximately 0 to 1500 m above sea level) |
| Acoustic noise | During operation (including using the autocutter) | Approximately 56 dB (ANSI Bystander position) (Based on Epson evaluation conditions including the use of the autocutter) |

External Dimensions

- Height: 261 mm
- Width: 310 mm
- Depth: 283 mm

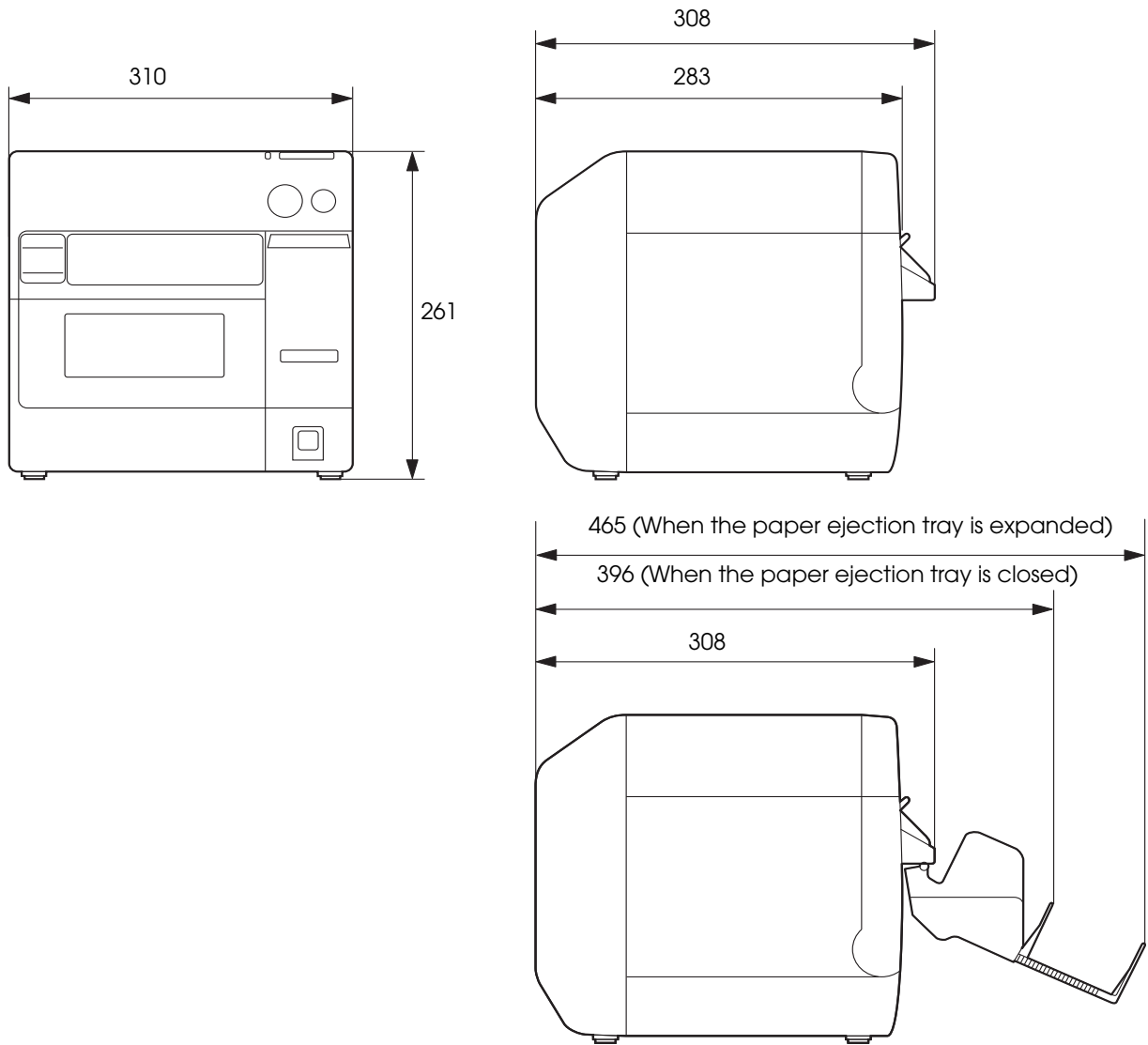

(Unit: mm)

Restrictions

- ❑ If you turn the power off the product using the power switch, the print head is automatically capped, which prevents the ink from drying. After installing the ink cartridges, be sure to turn the power off using the power switch when you are not using the product. Do not pull out the power plug or trip the breaker while the power is on.
- ❑ Printing on water-repellent paper such as art paper, which is slow-drying, may cause print stains. Also, printing on glossy paper may cause finger prints on the paper or ink may adhere to your fingers when you touch it. Select paper not to cause print stains before use.